



ASI533 Manual

Revision 1.1

Aug, 2020

All material in this publication is subject to change without notice and its copyright totally belongs to Suzhou ZWO CO.,LTD.



ASI533 Manual	1
1. Instruction	3
2. What's in the box?.....	4
3. Camera technical specifications	5
4. QE Value & Read Noise	6
5. Getting to know your camera.....	8
5.1 External View.....	8
5.2 Power consumption.....	9
5.3 Cooling system.....	11
5.4 Back focus distance.....	11
5.5 Protect Window.....	12
5.6 Analog to Digital Converter (ADC).....	12
5.7 Binning.....	12
5.8 DDR Buffer.....	12
6. How to use your camera.....	13
7. Cleaning	15
8. Mechanical drawing.....	16
9. Servicing	17
10. Warranty	17

1. Instruction

Congratulations and thank you for buying one of our ASI Cameras! This manual will give you a brief introduction to your ASI camera. Please take the time to read it thoroughly, if you have any questions, feel free to contact us: info@zwoptical.com.

The ASI533 camera is specifically designed with astrophotography in mind. It is not only suitable for deep space photography, but also for planetary photography. We are sure that the outstanding performance and wide range of uses for the ASI533MC PRO will amaze you.

Model	Mono or Color	Regulated TEC Cooling	DDR3 Cache	Sensor
ASI533MC PRO	Colour	YES	256MB	SONY IMX533

For software installation instructions and other technical information please refer to our official website: <https://astronomy-imaging-camera.com/>

2. What's in the box?

ASI533MC Pro



camera bag



camera body

1.25"
T-MountUSB 2.0 cable
(0.5m) x2USB 3.0 cable
(2m)T2-M48 16.5mm
extenderT2 21mm
extenderM42-M48
adapterT2-1.25"
adapter

spacer x3

3. Camera technical specifications

Sensor	SONY IMX533CMOS
Diagonal	15.968mm
Resolution	9 Mega Pixels 3008*3008
Pixel size	3.76 μ m
Image area	11.31*11.31mm
Max FPS at full resolution	20FPS
Shutter	Rolling Shutter
Exposure Range	32 μ s~2000s
Read noise	1.0-3.8e
QE peak	About 80%
Full well	50,000e
ADC	14bit
DDR3 buffer	256MB
Interface	USB3.0/USB2.0
Adapters	M42X0.75
Protective window	AR window
Dimensions	78mm
Weight	470g
Back focus distance	6.5mm/17.5mm
Cooling	Two Stage TEC
Delta T	35 $^{\circ}$ C below ambient
Cooling Power consumption	12V at 3A Max
Supported OS	Windows, Linux & Mac OSX

4. QE Value & Read Noise

The QE value and readout noise are the most important parameters to measure camera performance. Higher QE and lower readout noise are necessary to improve the image signal-to-noise ratio.

We suppose the QE peak of ASI533 is above 80%.

Readout noise includes pixel noise, circuit noise, and ADC quantization noise. The lower the readout noise, the better. As can be seen, compared with the conventional CCD camera, the readout noise value of the ASI533 is very low, and as the gain value increases, the readout noise is further reduced.

The parameter settings vary depending on your shooting target. If you turn down the gain, the dynamic range will be larger (suitable for long exposure) or increase the gain, and the readout noise will be further reduced (suitable for short exposure or fortunate imaging).

Read noise, full well, gain and dynamic range for ASI533

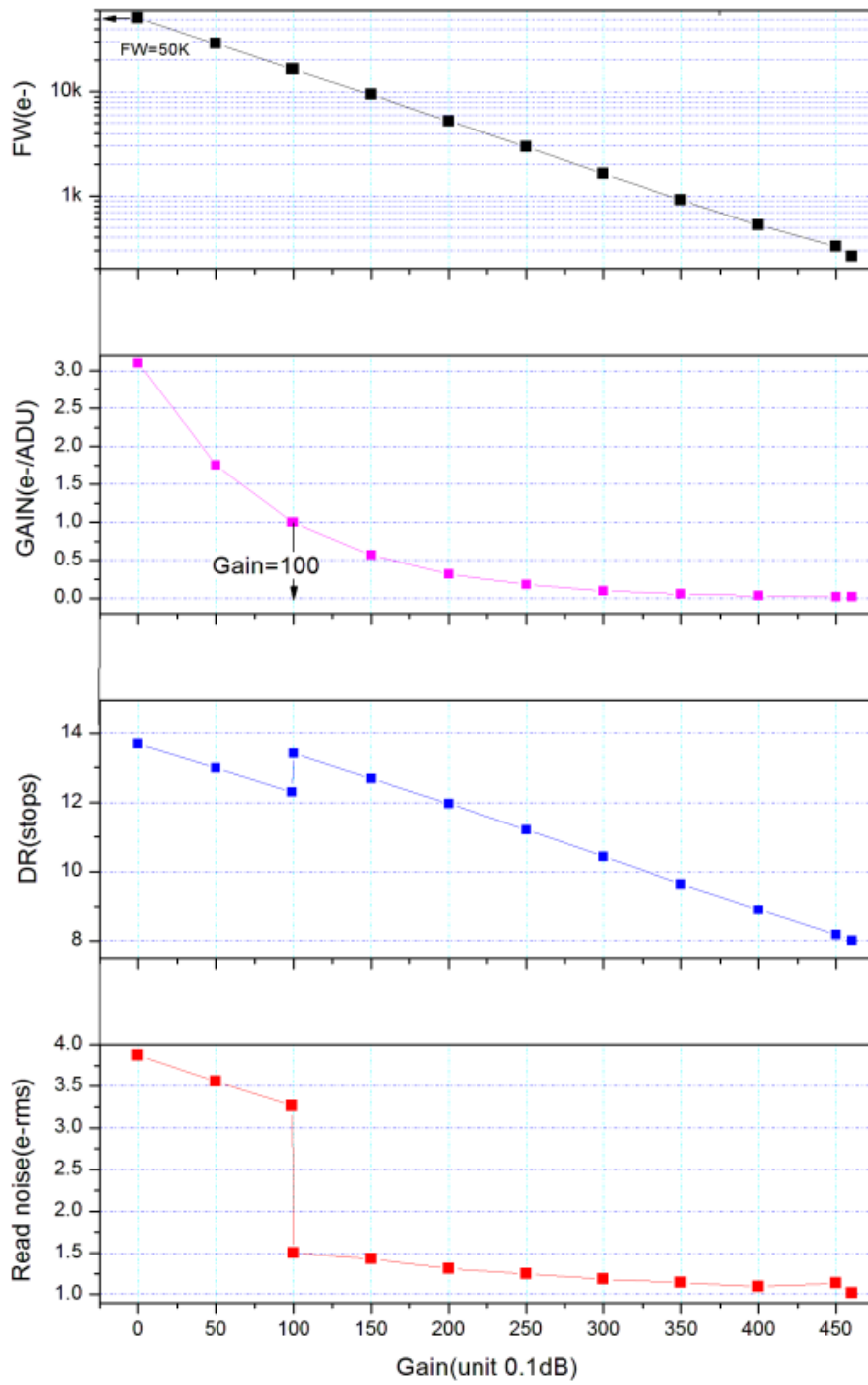

5. Getting to know your camera

5.1 External View



1. Protective window, AR anti-reflection film D32*2mm
2. 2" M42 thread, thickness 11mm, removable
3. Radiator
4. USB2.0Hub
5. USB3.0/USB2.0 data interface
6. Led indicator
7. Cooling power supply DC power port: size 5.5*2.1mm, inside and outside negative, it is recommended to use 12V at 3A power supply
8. Ultra-quiet magnetic suspension fan

There is 1/4" screw under the holder.



5.2 Power consumption

ASI cameras are low-power. When the camera is powered by a USB cable and not cooling, the power consumption is only 2.5W. While in cooling, you need to use a 12V at 3A power adapter (D5.5*2.1mm, center positive) or a lithium battery (supporting a wide range of 11V to 15V) to power the fans, and the maximum power consumption is about 22W.

The figure below shows the cooling efficiency of the ASI533. The cooling temperature difference of 30 degrees requires only 0.7A.

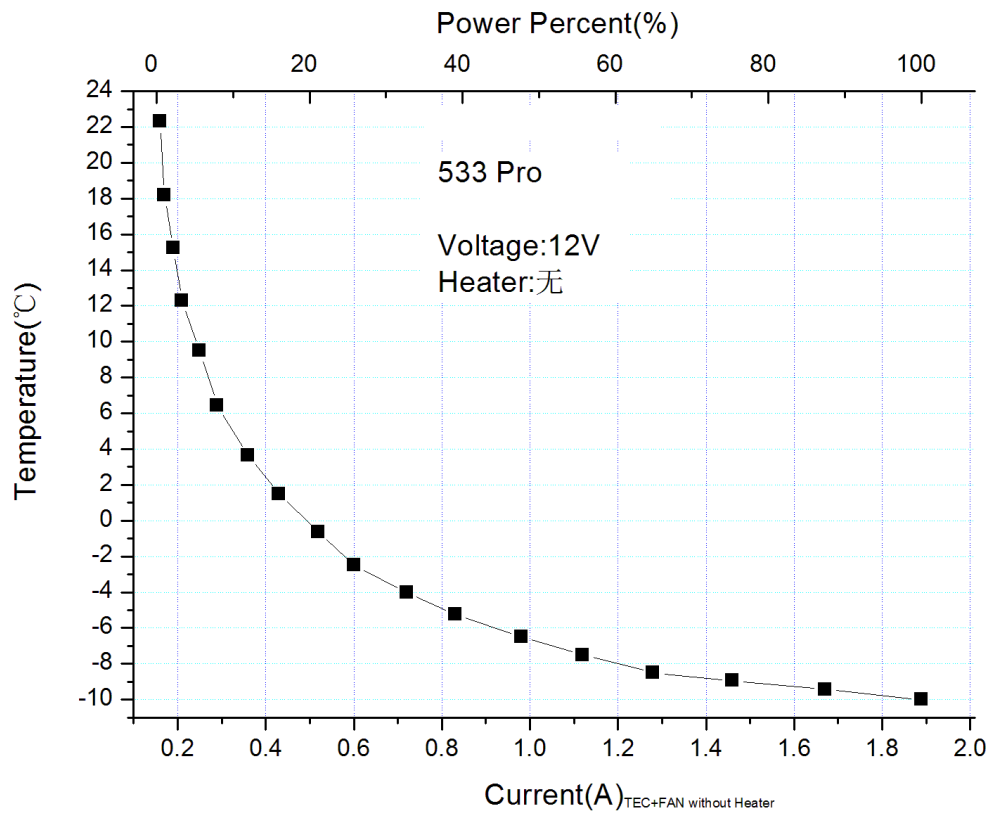

5.3 Cooling system

The ASI533 2-stage TEC cooling system precisely controls the temperature of the sensor. Unlike traditional CCDs, the ASI533 camera features ultra-low readout noise, efficient cooling, and adjustable gain. This eliminates the need for ultra-long exposures to capture targets, dramatically reducing the need for photographic systems and guide systems. However, if a short exposure is used (eg, less than 100ms, cooling has little effect on the image) the cooling system can be set to a minimum of $-35\text{ }^{\circ}\text{C}$ below ambient.

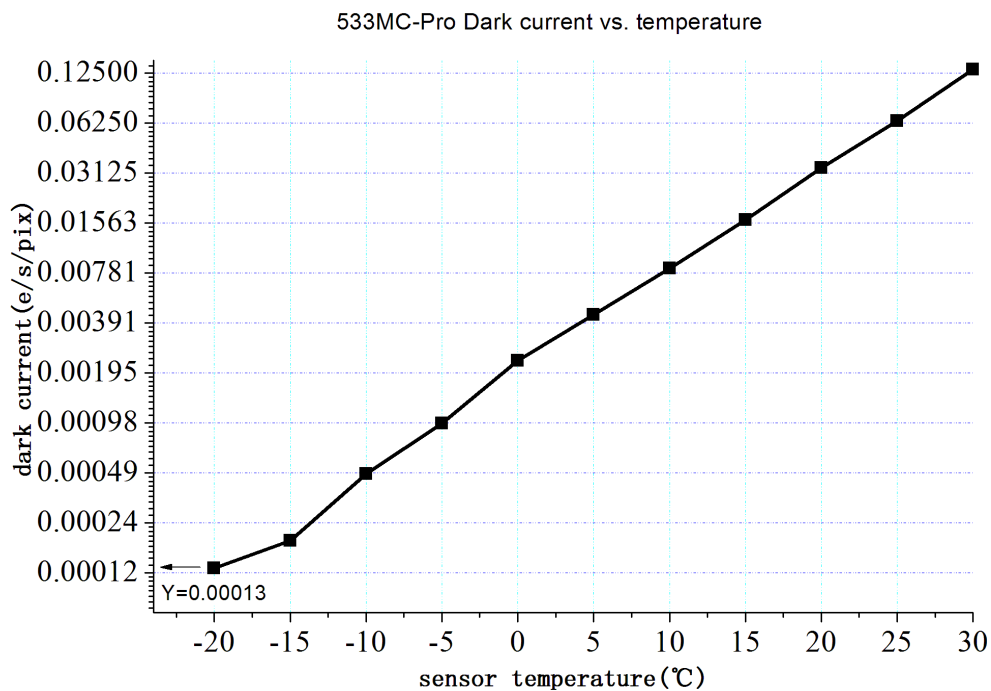

5.4 Back focus distance

When 11mm T2 Extender is removed from camera, back focus length is reduced to 6.5mm.

5.5 Protect Window

In front of the ASI533 camera sensor there is an AR coated protection window with a diameter of 32mm and a thickness of 2mm.

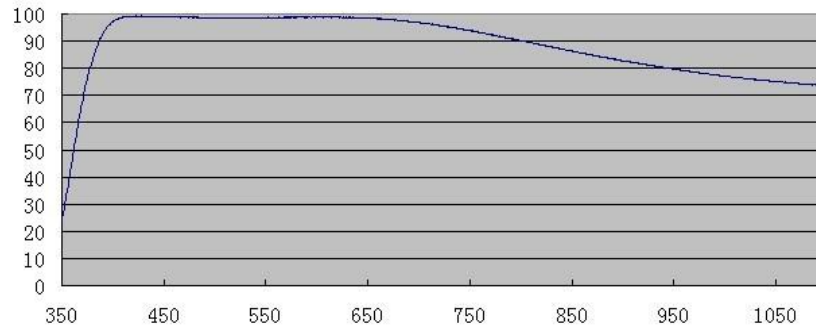

5.6 Analog to Digital Converter (ADC)

The ASI533 camera has a built-in 14bit ADC. The ASI533 also supports a custom ROI local readout mode with faster frame rates at small ROI resolutions. The following figure shows the frame rate of the ASI533 in 14bit mode, USB3.0 and USB2.0 at different resolutions:

Resolution	14Bit ADC	
	USB2.0	USB3.0
3008*3008	2fps	20fps
1920*1080	10fps	54fps
1280*720	24fps	80fps
640*480	70fos	117fps
320*240	216fps	216fps

5.7 Binning

The ASI533 camera supports bin2, bin3 and bin4 software pixel binning modes. The biggest benefit of hardware pixel binning is the faster frame rate. If you do not require increased frame rate, then we recommend software binning.

5.8 DDR Buffer

The ASI533MC Pro camera has built-in 256MB DDR3 high-speed memory to buffer image data, ensuring stable data transmission, and effectively reducing the amp-glow caused by slow

reading speed. The key difference between “Cool” and “Pro” model ASI cameras is that the Pro models have this built-in DDR memory buffer.

6. How to use your camera

The ASI533 can be connected to a telescope or camera lens via the necessary adapters. Most of the commonly needed adapters are already included and the rest can be purchased directly from our website: <https://astronomy-imaging-camera.com/>

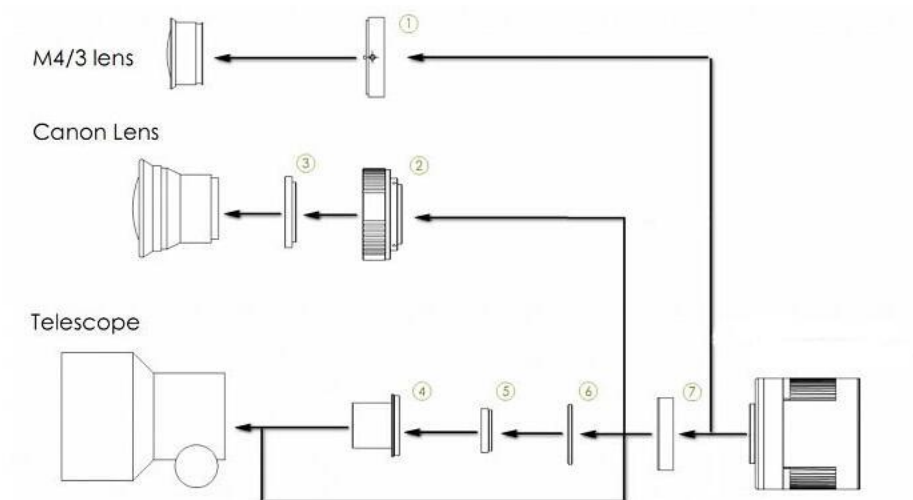

1. M43-T2 adapter
2. EOS-T2 adapter
3. 2" Filter (optional)
4. 1.25" T-Mount
5. 1.25" Filter (optional)
6. M42-1.25" Filter (optional)
7. T2 extender 11mm

Here is an example of the whole setup including an OAG and guider camera.

Planetary/Guide Cameras
External Device Connecting Drawing

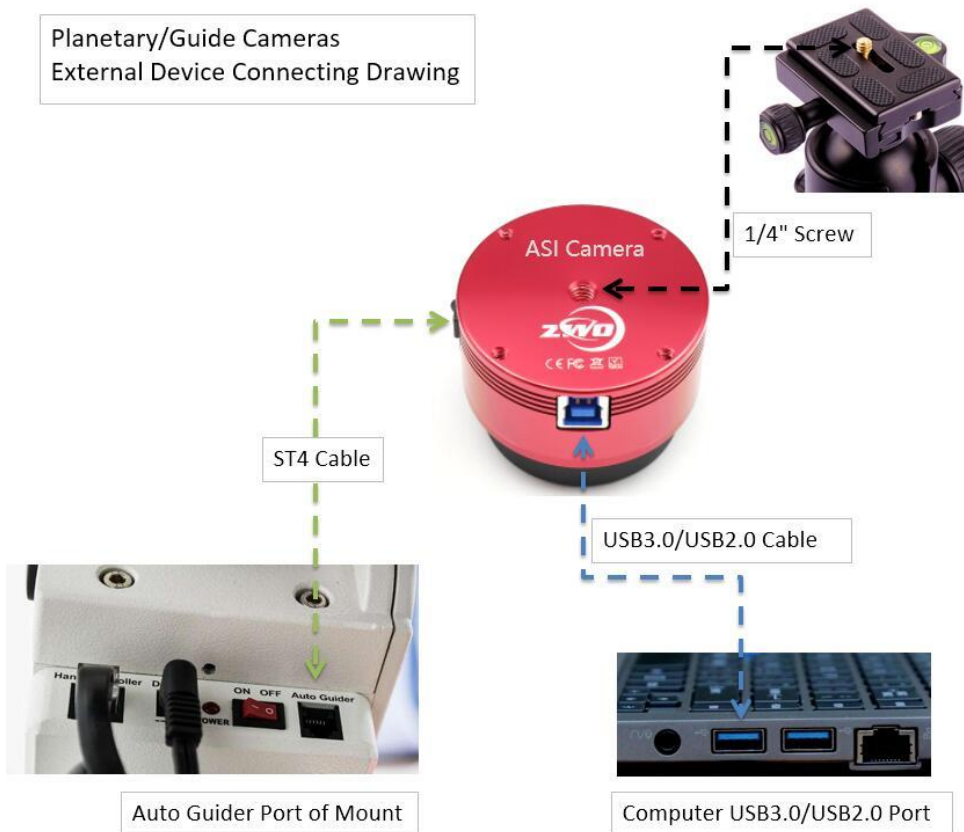

Cooled Cameras
External Device Connecting Drawing



7. Cleaning

The camera is equipped with a protective window glass. The inside of the sensor is dry and sealed. We do not recommend opening the camera to clean it. Opening the camera may cause the sensor room to get wet and condensation may occur during cooling. If you need to clean the protective glass, it is best during the day.

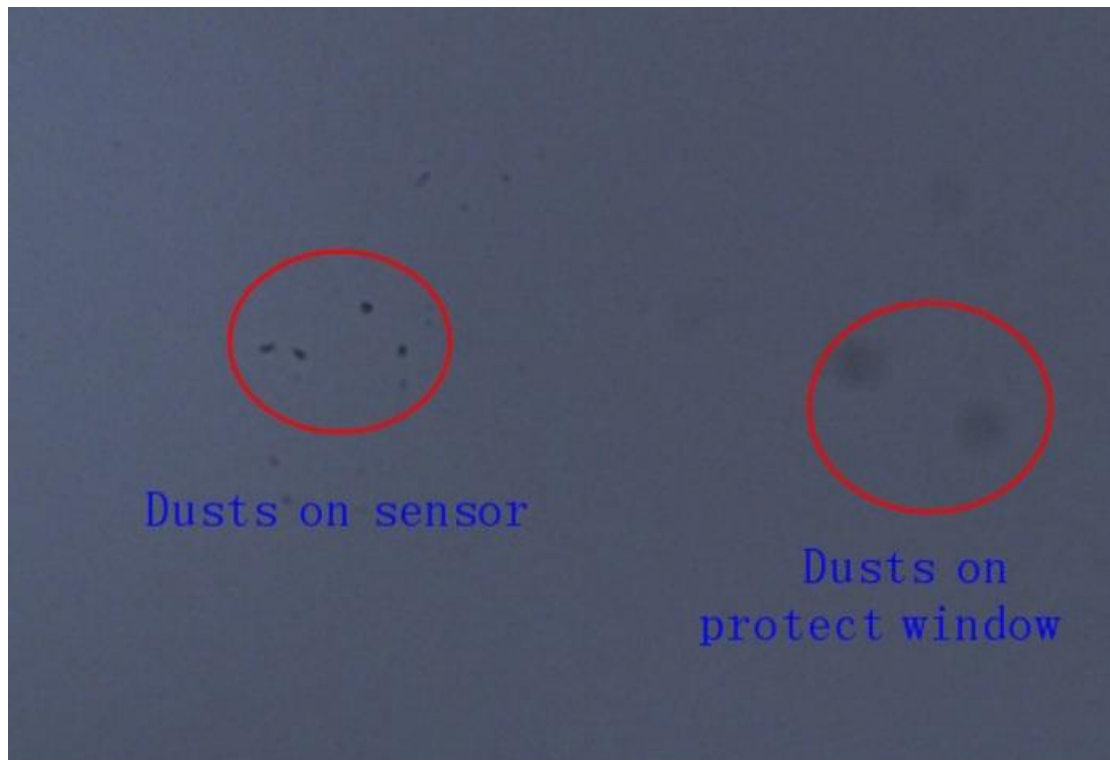

The dark spot on the right is the shadow of dust on the protective glass. The very small black spot on the left is the shadow of dust on the chip. In the above situation, it is recommended to blow off the dust on the glass surface with air. The remaining dust is recommended to be removed with calibration flat frames.

8. Mechanical drawing

ASI533MC Pro

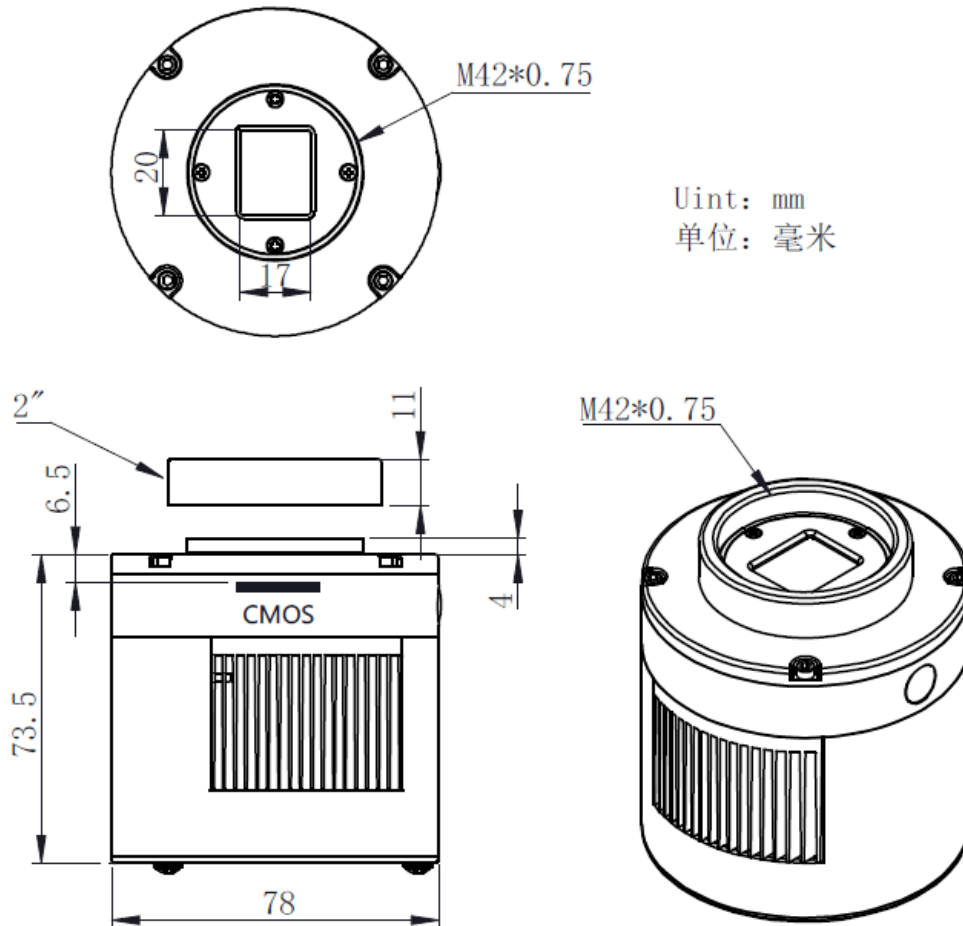

9. Servicing

For software upgrades, please go directly to the following official website to download updates:

<https://astronomy-imaging-camera.com/software-drivers>

For repairs and other services, please contact us via email: info@zwoptical.com

For cameras purchased from agents, please contact your dealer for after-sales service.

10. Warranty

We provide 2-year warranty for our products, we will offer the repair service for free or replace for free if the camera doesn't work within warranty period. After the warranty period, we will continue to provide repair support and service on a charged basis.

This warranty does not apply to damage that occurred as a result of abuse or misuse, or caused by a fall or any other transportation failures after purchase.

Customer must pay for shipping when shipping the camera back for repair or replacement

If you get a faulty camera, please contact us as soon as possible through email: info@zwoptical.com. Please describe the problem in detail and we will do our best to help you solve the problem. Most instances perceived problems are simply bad driver install or software configuration.