



CPC DELUXE HD[®]

SERIES

INSTRUCTION MANUAL

#11007 / #11008 / #11009



TABLE OF CONTENTS

INTRODUCTION	2
ASSEMBLY	4-7
THE HAND CONTROL	8-17
TELESCOPE BASICS	18-19
ASTRONOMY BASICS	20-22
CELESTIAL OBSERVING	23-24
CELESTIAL PHOTOGRAPHY	25-29
TELESCOPE MAINTENANCE	30-31
OPTIONAL ACCESSORIES	31-32
APPENDIX A - TECHNICAL SPECIFICATIONS	33-34
APPENDIX B - GLOSSARY OF TERMS	34-36
APPENDIX C – RS-232 CONNECTION	37
APPENDIX D – MAPS OF TIME ZONES	38-39
APPENDIX E – SKY MAPS	40-45
OBSERVATIONAL DATA SHEET	46
WARRANTY	47

INTRODUCTION

Congratulations on your purchase of the Celestron CPC DeluxeHD telescope! The CPC DeluxeHD combines Celestron's newly designed CPC Computerized mount with its new EdgeHD optical system. The CPC series uses GPS (Global Positioning System) technology to take the guesswork and effort out of aligning and finding celestial objects in the sky. Simple and easy to use, the CPC with its SkyAlign sky modeling system, is up and running after locating just three celestial objects. It's so advanced that once you turn it on, the integrated GPS automatically pinpoints your exact coordinates. No need to enter the date, time, longitude and latitude or even know the name of a single star in the sky.

If you are new to astronomy, you may wish to start off by using the CPC's built-in Sky Tour feature, which commands the CPC to find the most interesting objects in the sky and automatically slews to each one. Or if you are more experienced, you will appreciate the comprehensive database of over 40,000 objects, including customized lists of all the best deep-sky objects, planets and bright double stars. No matter at what level you are starting out, the CPC will unfold for you and your friends all the wonders of the Universe.

Some of the many standard features of the CPC DeluxeHD include:

- EdgeHD optical system
- Integrated Global Positioning System for easy alignment
- Fully enclosed optical encoders for position location
- Ergonomically designed hand controller – built into the side of the fork arm
- Database filter limits for creating custom object lists
- Storage for programmable user defined objects; and many other high performance features!

The CPC DeluxeHD's features combined with Celestron's legendary optical systems give amateur astronomers the most sophisticated and easy to use telescopes available on the market today.

Take time to read through this manual before embarking on your journey through the Universe. It may take a few observing sessions to become familiar with your CPC, so you should keep this manual handy until you have fully mastered your telescope's operation. The CPC hand control has built-in instructions to guide you through all the alignment procedures needed to have the telescope up and running in minutes. Use this manual in conjunction with the on-screen instructions provided by the hand control. The manual gives detailed information regarding each step as well as needed reference material and helpful hints guaranteed to make your observing experience as simple and pleasurable as possible.

Your CPC telescope is designed to give you years of fun and rewarding observations. However, there are a few things to consider before using your telescope that will ensure your safety and protect your equipment.

WARNING



- **Never look directly at the Sun with the naked eye or with a telescope (unless you have the proper solar filter). Permanent and irreversible eye damage may result.**
- Never use your telescope to project an image of the Sun onto any surface. Internal heat build-up can damage the telescope and any accessories attached to it.
- Never use an eyepiece solar filter or a Herschel wedge. Internal heat build-up inside the telescope can cause these devices to crack or break, allowing unfiltered sunlight to pass through to the eye.
- Never leave the telescope unsupervised, either when children are present or adults who may not be familiar with the correct operating procedures of your telescope.



FIGURE 3 CPC DELUXE 1100 HD SHOWN

- | | | |
|------------------------------|--------------------------------------|---|
| 1. Control Panel (see below) | 7. Finderscope Quick Release Bracket | 12. Azimuth Locking Knob |
| 2. Mirror Clutch Knobs | 8. Optical Tube | 13. Tripod |
| 3. Star Diagonal | 9. Schmidt Corrector Lens | 14. Accessory Tray / Center Support Bracket |
| 4. Hand Control | 10. Altitude Locking Knobs | 15. Focus Knob |
| 5. Eyepiece | 11. Carrying Handle | |
| 6. Finderscope | | |
-
- | | | |
|----------------------|----------------------|-------------------|
| A. Hand Control Port | C. PC Interface Port | E. On/Off Switch |
| B. Auxiliary Ports | D. Auto Guider Port | F. 12v Input Jack |

ASSEMBLY

The CPC DeluxeHD telescope comes completely pre-assembled and can be operational in a matter of minutes. The CPC and its accessories are conveniently packaged in one reusable shipping carton while the tripod comes in its own box. Included with your telescope are the following:

	#11007 CPC Deluxe 800 HD	#11008 CPC Deluxe 925 HD	#11009 CPC Deluxe 1100 HD
Diameter	203 mm (8") Edge HD Optics	235 mm (9.25") Edge HD Optics	280 mm (11") Edge HD Optics
Focal Length	2032 mm f/10	2350 mm f/10	2800 mm f/10
Eyepiece	40 mm - 1.25" (51x)	23 mm - 2" (102x)	23 mm - 2" (122x)
Finderscope	9x50	9x50	9x50
Diagonal	90° - 1.25"	90° - 2" with 1.25" adapter	90° - 2" with 1.25" adapter
Mount	CPC Altazimuth	CPC Altazimuth	CPC Altazimuth
Tripod	2" Stainless Steel	2" Stainless Steel	2" Stainless Steel
Software	NexRemote Telescope Control Software with RS-232 cable	NexRemote Telescope Control Software with RS-232 cable	NexRemote Telescope Control Software with RS-232 cable
Power	Car Battery Adapter	Car Battery Adapter	Car Battery Adapter

>> ASSEMBLING THE CPC

Start by removing the telescope and tripod from their shipping cartons and set the telescope's round base on a sturdy flat surface. Always carry the telescope by holding it from the lower portion of the fork arm on the hand control side and from the handle on the opposite side. Remove all of the accessories from their individual boxes. Remember

to save all of the containers so that they can be used to transport the telescope. Before attaching the visual accessories, the telescope should be mounted on the tripod and the tube should be positioned horizontal to the ground.

Setting up the Tripod

For maximum rigidity, the Celestron heavy duty tripod has a leg support bracket/Accessory tray. This bracket fits snugly against the tripod legs, increasing stability while reducing vibration and flexure. However, the tripod must be shipped with the leg support bracket detached so the tripod legs can collapse. To set up the tripod:

1. Hold the tripod with the head up and the legs pointed toward the ground.
2. Pull the legs away from the central column until they will not separate any further. The top of each tripod leg presses against the tripod head to indicate maximum separation.
3. Remove the tension knob, located on the central column. See figure 3-1.
4. Place the leg support bracket over the central rod so that the cups on the end of each bracket are directly underneath each leg.
5. Rotate the tension knob until the bracket is secure against the tripod legs. **Do not over tighten.**

The tripod will now stand by itself. Once the telescope is attached to the tripod, readjust the tension knob to ensure that the leg support bracket is snug. Once again, do not over tighten!

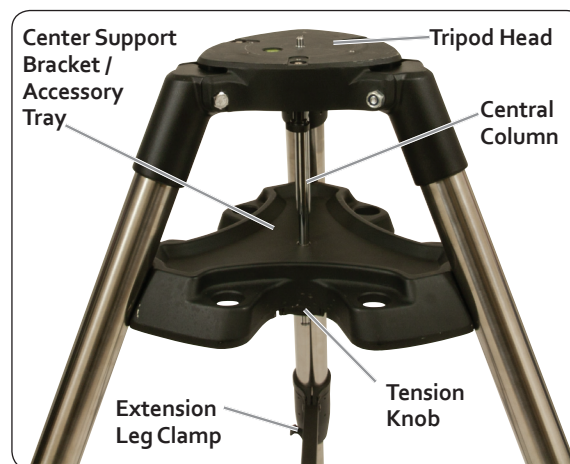

FIGURE 3-1

Adjusting the Tripod Height

The tripod that comes with your CPC telescope is adjustable. To adjust the height at which the tripod stands:

1. Loosen the extension clamp on one of the tripod legs (see figure 3-1).
2. Extend the leg to the desired height.
3. Tighten the extension clamp to hold the leg in place.
4. Repeat this process for each of the remaining legs making sure that the tripod is level when complete.

You can do this while the tripod legs are still folded together.

Remember that the higher the tripod legs are extended, the less stable it is. For casual observing, this may not pose a problem. However, if you plan on doing photography, the tripod should be set low to ensure stability. A recommended height is to set the tripod in such a manner that you can look directly into the eyepiece on the telescope with a diagonal while seated.

Attaching the CPC to the Tripod



FIGURE 3-2 MOUNTING THE TELESCOPE

After the tripod is set up, you are now ready to attach the telescope. The bottom of the CPC base has three threaded holes that mount to the tripod head and one hole in the center that goes over the positioning pin on the tripod head.

1. Place the center hole in the bottom of the telescope base over the positioning pin in the center of the tripod head.
2. Rotate the telescope base on the tripod head until the three feet on the bottom of the base fall into the feet recesses on the top of the tripod head.
3. Thread the three attached mounting bolts from underneath the tripod head into the bottom of the telescope base. Tighten all three bolts.

You are now ready to attach the visual accessories onto the telescope optical tube.

Adjusting the Clutches

The CPC has a dual axis clutch system. This allows you to move the telescope manually even when the telescope is not powered on. However, both clutches need to be tightened down for the telescope to be aligned for "GoTo" use. Any manual movement of the telescope will invalidate your telescope's alignment.

Before attaching your visual accessories, first loosen the altitude locking knob while holding the telescope tube by the rear cell handle. Rotate the tube upwards until it is level with the ground and tighten the locking knob.

>> www.celestron.com

Note: When transporting your telescope, make sure that both clutches are somewhat loose; this will diminish the load placed on the worm gear assemblies and protect them from damage.



FIGURE 3-3

THE CPC HAS AN ALTITUDE LOCKING KNOB (RIGHT) LOCATED ON THE FORK ARM AND AN AZIMUTH LOCKING KNOB (LEFT) LOCATED ON THE TOP OF THE BASE.

>> INSTALLING THE STAR DIAGONAL

The star diagonal is a prism or mirror that diverts the light at a right angle to the light path of the telescope. This allows you to observe in positions that are physically more comfortable than if you looked straight through.

To attach the 1.25" star diagonal onto the 8" optical tube:

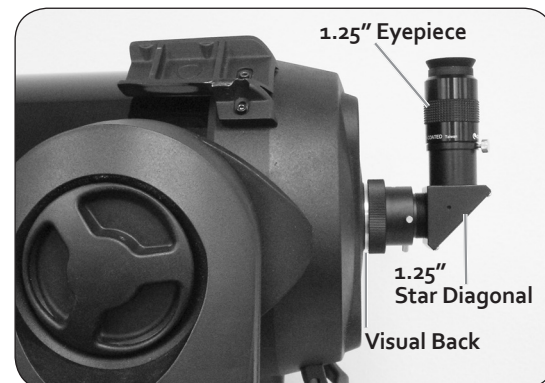

FIGURE 3-4 VISUAL ACCESSORIES FOR THE 8"

1. Turn the set screw on the visual back until its tip no longer extends into (i.e., obstructs) the inner diameter of the visual back.
2. Slide the chrome portion of the star diagonal into the visual back.
3. Tighten the set screw on the visual back to hold the star diagonal in place.

If you wish to change the orientation of the star diagonal, loosen the set screw on the visual back until the star diagonal rotates freely. Rotate the diagonal to the desired position and tighten the set screw.

To attach the 2" star diagonal onto the 9.25/11" optical tubes:

1. Remove the visual back from the rear of the tube.
2. Attach the threaded ring of the 2" diagonal to the rear cell of the telescope.
3. Loosen the thumb screws on the side of the diagonal and remove the 1.25" adapter from the barrel of the diagonal.

If you wish to change the orientation of the 2" star diagonal, loosen the retaining ring that attaches the diagonal to the rear cell. Rotate the diagonal to the desired position and tighten the retaining ring.

The Eyepiece

The eyepiece is the optical element that magnifies the image focused by the telescope. The eyepiece fits into either the visual back directly or the star diagonal. To install the eyepiece:

1. Loosen the thumbscrew on the star diagonal so it does not obstruct the inner diameter of the eyepiece end of the diagonal.
2. Slide the chrome portion of the eyepiece into the star diagonal.
3. Tighten the thumbscrew to hold the eyepiece in place.

To remove the eyepiece, loosen the thumbscrew on the star diagonal and slide the eyepiece out.

Eyepieces are commonly referred to by focal length and barrel diameter. The focal length of each eyepiece is printed on the eyepiece barrel. The longer the focal length (i.e., the larger the number) the lower the eyepiece power or magnification; and the shorter the focal length (i.e., the smaller the number) the higher the magnification. Generally, you will use low-to-moderate power when viewing. For more information on how to determine power, see the section on "Calculating Magnification."

Barrel diameter is the diameter of the barrel that slides into the star diagonal or visual back. The CPC uses eyepieces with a standard 1-1/4" barrel diameter.

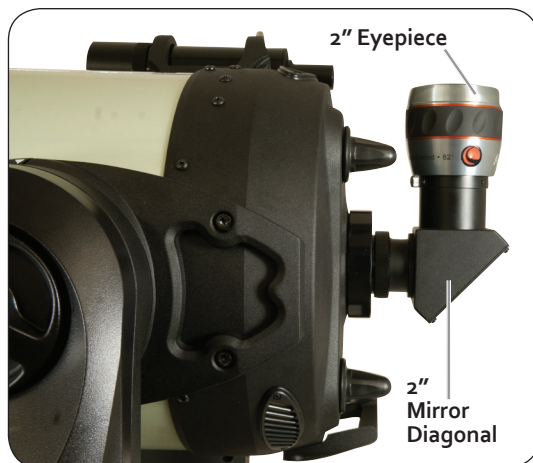

FIGURE 3-5

VISUAL ACCESSORIES FOR THE 9.25/11"

The Finderscope

The CPC telescope comes with a 9x50 finderscope. The specifications for a finderscope stand for the magnification and the aperture, in millimeters, of the scope. So, a 9x50 finder magnifies objects nine times and has a 50 mm objective lens.

Finderscope Installation

The finderscope must first be mounted in the included quick-release bracket then attached to the rear cell of the telescope. To install the finderscope:

1. Locate the finderscope mounting bracket attached to the bottom portion of the finder bracket. Loosen the two thumb screws to slide the mounting bracket from the finderscope bracket.
2. Find the two holes in the rear cell of the telescope on the top left, when looking from the back of the tube.
3. Place the mounting bracket over the two holes of the rear cell as shown in the figure 3-7.
4. Insert the screws through the bracket and into the rear cell.

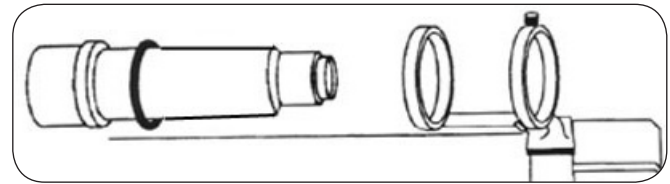

FIGURE 3-6

WARNING: If you remove the mounting bracket, do not completely thread the screws back into the rear cell of the telescope. The screws may be long enough to obstruct the movement of, and possibly damage the primary mirror.

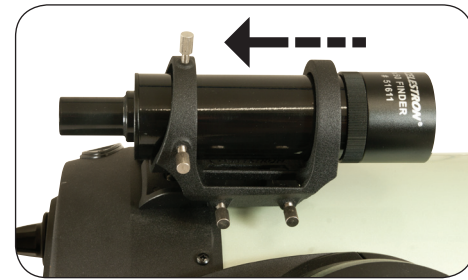
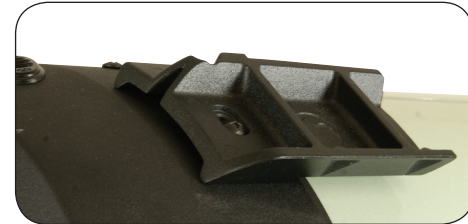

FIGURE 3-7

THE FINDERSCOPE BRACKET COMES IN TWO PIECES; THE MOUNTING BRACKET (TOP) AND THE FINDER BRACKET (BOTTOM)

With the bracket firmly attached to the telescope, you are ready to attach the finder to the bracket.

1. Slide the O-Ring over the back of the finderscope and position it on the tube toward the objective end of the finderscope.
2. Slide the eyepiece end of the finderscope into the front ring of the bracket (the front ring is the one without the adjustment screws), then through the back ring. It may be necessary to push down the spring loaded pivot screw so that the finder will pass through the back ring (see figure 3-6).
3. Push the finder back until the O-Ring is snug inside the front ring of the finder bracket.
4. Hand tighten the two adjustment thumb screws until they make contact with the finderscope.

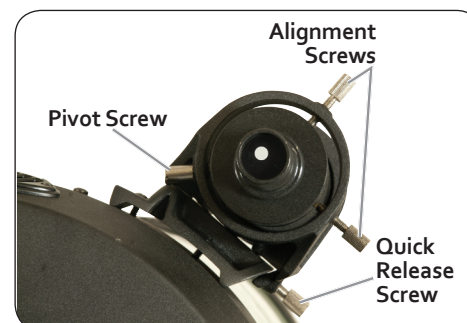

FIGURE 3-8

Aligning the Finderscope

The finderscope is adjusted using two adjustment screws, located on the top and on the right (when looking through the finder) of the finder bracket and a spring loaded pivot screw (located on the left side of the bracket). This allows you to turn the top adjustment screw to move the finderscope up and down, and turn the right adjustment screw to move the finderscope right to left. The spring loaded pivot screw puts constant pressure on the finder so that the adjustment screws are always making contact with the finder.

To make the alignment process a little easier, you should perform this task in the daytime when it is easier to locate objects in the telescope without the finder. To align the finder:

1. Choose a conspicuous object that is in excess of one mile away. This will eliminate any possible parallax effect between the telescope and the finder.
2. Point your telescope at the object you selected and center it in the main optics of the telescope.
3. Lock the azimuth and altitude clamps to hold the telescope in place.
4. Check the finder to see where the object is located in the field of view.
5. Adjust the thumb screws on the finder bracket until the cross hairs are centered on the target.

Remember that the image orientation through the finder is inverted (i.e., upside down and reversed from left-to-right). Because of this, it may take a few minutes to familiarize yourself with the directional change each screw has on the finder.

Attaching the Hand Control

In order to protect your CPC telescope during shipping, the hand control unit has been packaged along with the other telescope accessories and will need to be plugged in to the drive base of your telescope. The hand control cable has a phone jack style connector that will plug into the designated jack outlet located on the top of the drive base (see figure 3-10). Your telescope also comes with a hand control holder that must be attached to the fork arm. To connect the hand control to the fork arm:



FIGURE 3-9

- Locate the hand control holder and slide it down into the slot located on the fork arm (see figure 3-9).
- Push the connector into the jack until it clicks into place.

The hand control can now rest in the holder on the fork arm of the telescope.

Powering the CPC

The CPC can be powered by the supplied 12v car battery adapter or optional power supply (see Optional Accessories section in the back of this manual).

1. To power the CPC with the car battery adapter, simply plug the round post into the designated 12v power outlet located on the drive base.
2. Turn on the power to the CPC by flipping the On/Off switch.



FIGURE 3-10

HAND CONTROL

The CPC is controlled by Celestron's NexStar hand controller designed to give you instant access to all the functions the CPC has to offer. With automatic slewing to over 40,000 objects, and common sense menu descriptions, even a beginner can master its variety of features in just a few observing sessions. Below is a brief description of the individual components of the CPC's NexStar hand controller:

1. **Liquid Crystal Display (LCD) Window:** Has a dual-line, 16 character display screen that is backlit for comfortable viewing of telescope information and scrolling text.
2. **Align:** Instructs the CPC to use a selected star or object as an alignment position.
3. **Direction Keys:** Allows complete control of the CPC in any direction. Use the direction keys to move the telescope to the initial alignment stars or for centering objects in the eyepiece.
4. **Catalog Keys:** The NexStar hand control has keys to allow direct access to each of the catalogs in its database. The hand control contains the following catalogs in its database:

List – For quick access, all of the best and most popular objects in the NexStar database have been broken down into lists based on their type and/or common name:

Named Stars	Common name listing of the brightest stars in the sky.
Named Objects	Alphabetical listing of over 50 of the most popular deep sky objects.
Double Stars	Numeric-alphabetical listing of the most visually stunning double, triple and quadruple stars in the sky.
Variable Stars	Select list of the brightest variable stars with the shortest period of changing magnitude.
Asterisms	A unique list of some of the most recognizable star patterns in the sky.
CCD Objects	A custom list of many interesting galaxy pairs, trios and clusters that are well suited for CCD imaging with the CPC telescope.
IC Objects	A complete list of all the Index Catalog deep-sky objects.
Abell Objects	A complete list of all the Abell Catalog deep-sky objects.



FIGURE 4-1

THE NEXSTAR HAND CONTROL

Messier – Complete list of all Messier objects.

NGC – Complete list of all the deep-sky objects in the Revised New General Catalog.

Caldwell – A combination of the best NGC and IC objects.

Planets – All 8 planets in our Solar System plus the Moon and the Sun.

Stars – A compiled list of the brightest stars from the SAO catalog.

5. **Info:** Displays coordinates and useful information about objects selected from the NexStar database.
6. **Tour:** Activates the tour mode, which seeks out all the best objects for the current date and time, and automatically slews the CPC to those objects.
7. **Enter:** Pressing Enter allows you to select any of the CPC functions and accept entered parameters.
8. **Undo:** Undo will take you out of the current menu and display the previous level of the menu path. Press Undo repeatedly to get back to a main menu or use it to erase data entered by mistake.
9. **Menu:** Displays the many setup and utilities functions such as tracking rate and user defined objects and many others.
10. **Scroll Keys:** Used to scroll up and down within any of the menu lists. A double-arrow will appear on the right side of the LCD when there are sub-menus below the displayed menu. Using these keys will scroll through those sub-menus.
11. **Rate:** Instantly changes the rate of speed of the motors when the direction buttons are pressed.
12. **RS-232 Jack:** Allows you to interface with a computer and control the CPC remotely.

>> HAND CONTROL OPERATION

This section describes the basic hand control procedures needed to operate the CPC. These procedures are grouped into three categories: Alignment, Setup and Utilities. The alignment section deals with the initial telescope alignment as well as finding objects in the sky; the setup section discusses changing parameters such as tracking mode, tracking rate and setting filter and slew limits; finally, the last section reviews all of the utilities functions such as PEC, polar alignment and hibernating the telescope.

>> ALIGNMENT PROCEDURES

In order for the CPC to accurately point to objects in the sky, it must first be aligned to known positions (stars) in the sky. With this information,

the telescope can create a model of the sky, which it uses to locate any object with known coordinates. There are many ways to align the CPC with the sky depending on what information the user is able to provide: **SkyAlign** uses the internal GPS receiver to acquire all the necessary time/site information needed for the CPC to create an accurate model of the sky. Then the user can simply point the telescope to any three bright celestial objects to accurately align the telescope with the sky. **Auto Two-Star Align** will ask the user to choose and center the first alignment star, then the CPC will automatically select and slew to a second star for alignment. **Two-Star Alignment** requires the user to identify and manually slew the telescope to the two alignment stars. **One-Star Align** is the same as Two-Star Align; however, it only requires you to align to one known star. Although not as accurate as the other alignment methods, One-Star Align is the quickest way to find and track bright planets and objects in Altazimuth mode. **Solar System Align** will display a list of visible daytime objects (planets and the Moon) available to align the telescope. Finally, **EQ North and EQ South** alignments are designed to assist you in aligning the CPC when polar aligned using an equatorial wedge. Each alignment method is discussed in detail below.

"Altazimuth" or "Alt-Az" refers to a type of mounting that allows a telescope to move in both altitude (up and down) and azimuth (left and right) with respect to the ground. This is the simplest form of mounting in which the telescope is attached directly to a tripod without the use of an equatorial wedge.

SkyAlign

SkyAlign must be used with the telescope mounted in altazimuth. With SkyAlign, the GPS receiver links with and acquires information from 3 of the orbiting GPS satellites. With this information, the built-in GPS system calculates the scope's location on Earth with an accuracy of a few meters and calculates universal time down to the second. After quickly making all these calculations and automatically entering the information for you, the user simply needs to aim the telescope to any three bright celestial objects in the sky. Since SkyAlign requires no knowledge of the night sky, it is not necessary to know the name of the stars that you are aiming at. You may even select a planet or the Moon. The CPC is then ready to start finding and tracking any of the objects in its 40,000+ object database. Before the telescope is ready to be aligned, it should be set up in an outside location with all accessories (eyepiece, diagonal and finderscope) attached and lens cover removed as described in the Assembly section of the manual. To begin SkyAlign:

1. Power on the CPC by flipping the switch located on the control panel of the drive base to the "on" position. Once turned on, the hand control display will say **CPC Ready**. Press ENTER to choose *SkyAlign* or use the UP/DOWN scroll keys (10) to select a different method of alignment. Pressing the ALIGN key will bypass the other alignment options and the scrolling text and automatically begins *Sky Align*.
2. Once *Sky Align* has been selected, the hand control will display "Enter if OK", "Undo to Edit" and "GPS Linking". The bottom line of the LCD will display either the current time or the time when you last used the telescope. The GPS will quickly link up and display the current date, time and location. Additionally, you have the option of pressing UNDO and manually updating the time/site information. Press ENTER to accept the time/site information downloaded from the GPS.
3. The hand control will display a message reminding you to level the tripod if you already haven't done so. Press ENTER to continue.
4. Use the arrow buttons on the hand control to slew (move) the telescope towards any bright celestial object in the sky. Center the object in the crosshairs of the finderscope and press ENTER.

>> www.celestron.com

5. If the finderscope has been properly aligned with the telescope tube, the alignment star should now be visible inside the field of view of the eyepiece. The CPC will ask that you center the bright alignment star in the center of the eyepiece and press the ALIGN button. This will accept the star as the first alignment position. (There is no need to adjust the slewing rate of the motors after each alignment step. The CPC automatically selects the best slewing rate for aligning objects in both the finderscope and the eyepiece).
6. For the second alignment object, choose a bright star or planet as far as possible from the first alignment object. Once again use the arrow button to center the object in the finderscope and press ENTER. Then once centered in the eyepiece, press the ALIGN button.
7. Repeat the process for the third alignment star. When the telescope has been aligned to the final stars, the display will read **Match Confirmed**. Press UNDO to display the names of the three bright objects you aligned to, or press ENTER to accept these three objects for alignment. You are now ready to find your first object.

A Few Words on GPS:

The CPC uses an on-board GPS to take the guesswork out of aligning your telescope with the sky. Once an alignment method is selected, the CPC automatically initiates the internal GPS module. However, there are a few things you should be aware of in order to get full use of its many capabilities:

GPS alignment will only work when the telescope is set-up outdoors with an unobstructed view of the sky. If the CPC is set-up in a location that has a limited horizon in any direction, it may take longer for the telescope to find and link with the needed satellites.

When using the GPS for the first time, it may take 3-5 minutes for the CPC to link-up with its satellites. Once the telescope is successfully linked, leave the telescope powered on for at least 20 minutes. During this time the CPC will download the complete almanac of orbital elements (called the ephemeris) for the orbiting GPS satellites. Once this information is received, it will be stored for future alignments.

If your CPC is transported over a long distance (say from the northern to the southern hemisphere), it may take as long as one hour to establish a satellite link from its new location. Observers wishing to travel long distances with their telescope are advised to turn on their telescope in advance to allow the GPS to acquire the necessary data.

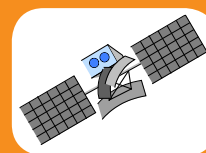

Tips for Using SkyAlign

Remember the following alignment guidelines to make using SkyAlign as simple and accurate as possible.

- Be sure to level the tripod before you begin alignment. The time/site information along with a level tripod will help the telescope better predict the available bright stars and planets that are above the horizon.
- Remember SkyAlign does not care where the optical tube is pointed at the beginning of the alignment. So to make the alignment process even faster, it is acceptable to move the telescope to the first alignment star manually by loosening both clutches. However the following alignment stars still need to be found and centered using the hand control.
- Remember to select alignment stars that are as far apart in the sky as possible. For best results, make sure that the third alignment star does not lie in a straight line between the first two stars. This may result in a failed alignment.

- Don't worry about confusing planets for stars when selecting alignment objects. SkyAlign works with the four brightest planets (Venus, Jupiter, Saturn and Mars) as well as the Moon. In addition to the planets, the hand control has over 80 bright alignment stars to choose from (down to 2.5 magnitude).
- Rarely SkyAlign will not be able to determine what three alignment objects were centered. This sometimes happens when a bright planet or the Moon passes near one of the brighter stars. In situations like these, it is best to try to avoid aligning to either object if possible.
- For the best possible pointing accuracy, always center the alignment stars using the same final movements as the direction of the GoTo Approach (by default this will be using the up arrow button and the right arrow button). Approaching the star from this direction when looking through the eyepiece will eliminate much of the backlash between the gears and assure the most accurate alignment possible.

Auto Two-Star Align

As with SkyAlign, Auto Two-Star Align downloads all the necessary time/site information from orbiting GPS satellites. Once this information is received, the CPC will prompt you to slew the telescope and point at one known star in the sky. The CPC now has all the information it needs to automatically choose a second star that will assure the best possible alignment. Once selected, the telescope will automatically slew to the second alignment star to complete the alignment. With the CPC set up outside with all accessories attached and the tripod leveled, follow the steps below to align the telescope:

1. Once the CPC is powered on, Press ENTER to begin alignment.
2. Use the Up and Down scroll keys (10) to select *Auto Two-Star Align* and press ENTER.
3. The hand control will display the last time and location information that was entered or downloaded from the GPS. Use the Up and Down buttons to scroll through the information. Press ENTER to accept the downloaded information or press UNDO to manually edit the information.
4. The display will now prompt you to select a bright star from the displayed list on the hand control. Use Up and Down buttons (6 and 9 on the keypad) to scroll to the desired star and then press ENTER.
5. Use the arrow buttons to slew the telescope to the star you selected. Center the star in the crosshairs of the finderscope and press ENTER. Finally, center the star in the eyepiece and press ALIGN.
6. Based on this information, the CPC will automatically display the most suitable second alignment star that is above the horizon. Press ENTER to automatically slew the telescope to the displayed star. If for some reason you do not wish to select this star (perhaps it is behind a tree or building), you can either:
 - Press the UNDO button to display the next most suitable star for alignment.
 - Use the UP and DOWN scroll buttons to manually select any star you wish from the entire list of available stars.

Once the desired star is displayed, press ENTER to automatically slew the telescope to the displayed star. When finished slewing, the display will ask you to use the arrow buttons to align the selected star with the cross hairs in the center of the finderscope. Once centered in the finder, press ENTER. The display will then instruct you to center the star in the field of view of the eyepiece. When the star is centered, press ALIGN to accept this star as your second alignment star. When the telescope has been aligned to both stars the display will read **Alignment Success**, and you are now ready to find your first object.

Two-Star Alignment

With the two-star alignment method, the CPC requires the user to know the positions of two bright stars in order to accurately align the telescope with the sky and begin finding objects. Here is an overview of the two-star alignment procedure:

1. Once the CPC is powered on, use the UP and DOWN scroll keys (10) to select Two-Star Align, and press ENTER.
2. Press ENTER to accept the time/site information displayed on the display, or wait until the telescope has downloaded the information from the GPS satellites.
3. The SELECT STAR 1 message will appear in the top row of the display. Use the UP and DOWN scroll keys (10) to select the star you wish to use for the first alignment star. Press ENTER.
4. CPC then asks you to center in the eyepiece the alignment star you selected. Use the direction arrow buttons to slew the telescope to the alignment star and carefully center the star in the finderscope. Press ENTER when centered.
5. Then, center the star in the eyepiece and press ALIGN

In order to accurately center the alignment star in the eyepiece, you may wish to decrease the slew rate of the motors for fine centering. This is done by pressing the RATE key (11) on the hand controller then selecting the number that corresponds to the speed you desire. (9 = fastest, 1 = slowest).

6. CPC will then ask you to select and center a second alignment star and press the ALIGN key. It is best to choose alignment stars that are a good distance away from one another. Stars that are at least 40° to 60° apart from each other will give you a more accurate alignment than stars that are close to each other.

Once the second star alignment is completed properly, the display will read **Alignment Successful**, and you should hear the tracking motors turn-on and begin to track.

One-Star Align

One-Star Align allows you to download all the same information as you would for the Two-Star Align procedure. However, instead of slewing to two alignment stars for centering and alignment, the CPC uses only one star to model the sky based on the information given. This will allow you to roughly slew to the coordinates of bright objects like the Moon and planets and gives the CPC the information needed to track objects in altazimuth in any part of the sky.

To use One-Star Align:

1. Select One-Star Align from the alignment options.
2. Press ENTER to accept the time/site information displayed on the display, or wait until the telescope has downloaded the information from the GPS satellites.
3. The SELECT STAR 1 message will appear in the top row of the display. Use the Up and Down scroll keys (10) to select the star you wish to use for the first alignment star. Press ENTER.
4. The CPC then asks you to center in the eyepiece the alignment star you selected. Use the direction arrow buttons to slew the telescope to the alignment star and carefully center the star in the finderscope. Press ENTER when centered.
5. Then, center the star in the eyepiece and press ALIGN
6. Once in position, the CPC will model the sky based on this information and display **Alignment Successful**.

Note: Once a One-Star Alignment has been done, you can use the Re-alignment feature (later in this section) to improve your telescope's pointing accuracy.

Solar System Align

Solar System Align is available in alt-az mode (scope mounted directly on the tripod) and equatorial mode (scope mounted on a wedge). Solar System Align is designed to provide excellent tracking and GoTo performance by using solar system objects (Sun, Moon and planets) to align the telescope with the sky. Solar System Align is a great way to align your telescope for daytime viewing as well as a quick way to align the telescope for night time observing.



Never look directly at the Sun with the naked eye or with a telescope (unless you have the proper solar filter). Permanent and irreversible eye damage may result.

1. Select Solar System Align from the alignment options.
2. Press ENTER to accept the time/site information displayed on the display, or wait until the telescope has downloaded the information from the GPS satellites.
3. The SELECT OBJECT message will appear in the top row of the display. Use the Up and Down scroll keys (10) to select the daytime object (planet, Moon or Sun) you wish to align. Press ENTER.
4. The CPC then asks you to center in the eyepiece the alignment object you selected. Use the direction arrow buttons to slew the telescope to the alignment object and carefully center it in the finderscope. Press ENTER when centered.
5. Then, center the object in the eyepiece and press ALIGN.

Once in position, the CPC will model the sky based on this information and display **Alignment Successful**.

Tips for Using Solar System Align

- For safety purposes, the Sun will not be displayed in any of the hand control's customer object lists unless it is enabled from the Utilities Menu. To allow the Sun to be displayed on the hand control, do the following:

1. Press the UNDO button until the display reads "CPC Ready".
2. Press the MENU button and use the Up and Down keys to select the *Utilities Menu*. Press ENTER.
3. Use the UP and Down keys to select *Sun Menu* and press ENTER.
4. Press ENTER again to allow the Sun to appear on the hand control display.

The Sun can be removed from the display by using the same procedure as above.

- To improve the telescope pointing accuracy, you can use the Re-Align feature as described below.

EQ North / EQ South Alignment

EQ North and EQ South Alignments assist the user in aligning the telescope when polar aligned on an optional equatorial wedge. Similar to the Altazimuth alignments described earlier, the EQ alignments gives you the choice of performing an AutoAlign, Two-Star alignment, One-Star alignment or Solar System alignment.

EQ AutoAlign

The EQ AutoAlign uses all the same time/site information as the Alt-Az alignments, however it also requires you to position the tube so that the

altitude index markers are aligned (see figure 4-2), and then rotate the telescope base until the tube is pointed towards the Meridian (see figure 4-3). Based on this information the CPC will automatically slew to two selected alignment stars to be centered and aligned. To use EQ Auto-Align:

1. Select EQ North or South Align from the alignment options and press ENTER
2. Press ENTER to accept the time/site information displayed on the display, or wait until the telescope has downloaded the information from the GPS satellites.
3. Select EQ AutoAlign method and press ENTER
4. Use the up and down arrow buttons to move the telescope tube upwards until the altitude index markers are aligned. The altitude index markers are located at the top of the fork arm. See figure 4-2.
5. Use the left and right arrow buttons to move the telescope base until the fork arms are horizontally parallel and the tube is pointing towards the Meridian.
6. Based on this information, the CPC will automatically display the most suitable alignment stars that are above the horizon. Press ENTER to automatically slew the telescope to the displayed star. If for some reason you do not wish to select one of these stars (perhaps it is behind a tree or building), you can either:
 - Press the UNDO button to display the next most suitable star for alignment.
 - Use the UP and DOWN scroll buttons to manually select any star you wish from the entire list of available stars.
7. CPC then asks you to center in the eyepiece the alignment object you selected. Use the direction arrow buttons to slew the telescope to the alignment object and carefully center it in the finderscope. Press ENTER when centered.
8. Then, center the object in the eyepiece and press ALIGN.
9. Once you press the ALIGN button, the telescope will automatically slew to a second alignment star. Repeat steps 6 and 7 to complete alignment.



FIGURE 4-2

ALTITUDE INDEX MARKERS

EQ Two-Star Align

The EQ Two-Star Align follows most of the same steps as the Alt-Az Two-Star Align. This alignment method does not require the user to align the altitude index markers or point towards the Meridian, but it does require the user to locate and align the telescope on two bright stars. When selecting alignment stars, it is best to choose stars that, a) have a large separation in azimuth and b) both are either positive or negative in declination. Following these two guidelines will result in a more accurate EQ Two-Star alignment.

EQ One-Star Align

EQ One-Star Align operates much the same way as EQ Two-Star Align, however it only relies on the alignment of one star to align the telescope. To use EQ One-Star Align follow the same steps as you would for EQ Two-Star Align, but only using one star.

EQ Solar System Align

This alignment method allows you to use only one solar system object to equatorially align the telescope for daytime use. To align your telescope using a solar system object, follow steps 1 through 7 under the EQ Two-Star Align section.

CPC Re-Alignment

The CPC has a re-alignment feature which allows you to replace either of the original alignment stars with a new star or celestial object. This can be useful in several situations:

- If you are observing over a period of a few hours, you may notice that your original alignment stars have drifted towards the west considerably. (Remember that the stars are moving at a rate of 15° every hour). Aligning on a new star that is in the eastern part of the sky will improve your pointing accuracy, especially on objects in that part of the sky.
- If you have aligned your telescope using the One-Star or Solar System alignment method, you can use re-align to align to additional objects in the sky. This will improve the pointing accuracy of your telescope without having to re-enter addition information.

To replace an existing alignment star with a new alignment star:

1. Select the desired star (or object) from the database and slew to it.
2. Carefully center the object in the eyepiece.
3. Once centered, press the UNDO button until you are at the main menu.
4. With **CPC Ready** displayed, press the ALIGN key on the hand control.
5. The display will then ask you which alignment star you want to replace. Use the UP and DOWN scroll keys to select the alignment star to be replaced. It is usually best to replace the star closest to the new object. This will space out your alignment stars across the sky. If you have used one of the single object alignment methods, then it is always best to replace the object that is "unassigned" with an actual object.
6. Press ALIGN to make the change.

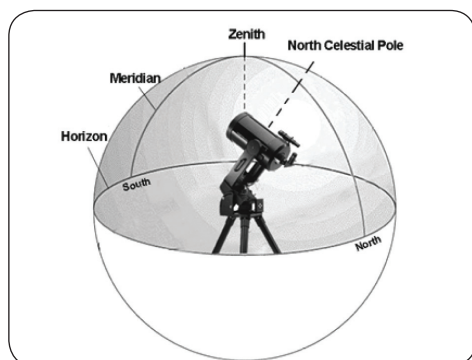

FIGURE 4-3

THE MERIDIAN IS AN IMAGINARY LINE IN THE SKY THAT STARTS AT THE NORTH CELESTIAL POLE AND ENDS AT THE SOUTH CELESTIAL POLE AND PASSES THROUGH THE ZENITH. IF YOU ARE FACING SOUTH, THE MERIDIAN STARTS FROM YOUR SOUTHERN HORIZON AND PASSES DIRECTLY OVERHEAD TO THE NORTH CELESTIAL POLE.

>> SELECTING AN OBJECT

Now that the telescope is properly aligned, you can choose an object from any of the catalogs in the CPC's extensive database. The hand control has a key (4) designated for each of the catalogs in its database. There are two ways to select objects from the database: scrolling through the named object lists and entering object numbers.

Pressing the LIST key on the hand control will access all objects in the database that have common names or types. Each list is broken down into the following categories: Named Stars, Named Object, Double Stars, Variable Stars, Asterisms and CCD Objects. Selecting any one of these catalogs will display a numeric-alphabetical listing of the objects under that list. Pressing the UP and DOWN keys (10) allows you to scroll through the catalog to the desired object.

When scrolling through a long list of objects, holding down either the UP or DOWN key will allow you to scroll through the catalog at a rapid speed.

Pressing any of the other catalog keys (M, CALD, NGC or STAR) will display a blinking cursor below the name of the catalog chosen. Use the numeric key pad to enter the number of any object within these standardized catalogs. For example, to find the Orion Nebula, press the "M" key and enter "042".

When entering the number for a SAO star, you are only required to enter the first four digits of the objects six digit SAO number. Once the first four digits are entered, the hand control will automatically list all the available SAO objects beginning with those numbers. This allows you to scroll through only the SAO stars in the database. For example, in searching for the SAO star 40186 (Capella), the first four digits would be "0401". Entering this number will display the closest match from the SAO stars available in the database. From there you can scroll down the list and select the desired object.

>> SLEWING TO AN OBJECT

Once the desired object is displayed on the hand control screen, choose from the following options:

- Press the INFO Key. This will give you useful information about the selected object such as R.A. and declination, magnitude size and text information for many of the most popular objects.
- Press the ENTER Key. This will automatically slew the telescope to the coordinates of the object.

Caution: Never slew the telescope when someone is looking into the eyepiece. The telescope can move at fast slew speeds and may hit an observer in the eye.

If you manually enter an object that is below the horizon, CPC will notify you by displaying a message reminding you that you have selected an object outside of your slew limits (see Slew Limits in the Scope Setup section of the manual). Press UNDO to go back and select a new object. Press ENTER to ignore the message and continue the slew.

Object information can be obtained without having to do a star alignment. After the telescope is powered on, pressing any of the catalog keys allows you to scroll through object lists or enter catalog numbers and view the information about the object as described above.

>> FINDING PLANETS

The CPC can locate all 8 of our solar systems planets plus the Sun and Moon. However, the hand control will only display the solar system objects that are above the horizon (or within its filter limits). To locate the planets, press the PLANET key on the hand control. The hand control will display all solar system objects that are above the horizon:

- Use the **Up and Down** keys to select the planet that you wish to observe.
- Press INFO to access information on the displayed planet.
- Press ENTER to slew to the displayed planet.

To allow the Sun to be displayed as an option in the database, see Sun Menu in the Utilities section of the manual (pg. 15).

>> TOUR MODE

The CPC includes a tour feature which automatically allows the user to choose from a list of interesting objects based on the date and time in which you are observing. The automatic tour will display only those objects that are within your set filter limits (see *Filter Limits* in the Scope Setup Features section of the manual on page 15). To activate the Tour mode, press the TOUR key (6) on the hand control. The CPC will display the best objects to observe that are currently in the sky.

- To see information and data about the displayed object, press the INFO key.
- To slew to the object displayed, press ENTER.
- To see the next tour object, press the UP key.

>> CONSTELLATION TOUR

In addition to the Tour Mode, the CPC telescope has a Constellation Tour that allows the user to take a tour of all the best objects within a particular constellation. Selecting Constellation from the LIST menu will display all the constellation names that are above the user defined horizon (filter limits). Once a constellation is selected, you can choose from any of the database object catalogs to produce a list of all the available objects in that constellation.

- To see information and data about the displayed object, press the INFO key.
- To slew to the object displayed, press ENTER.
- To see the next tour object, press the UP key.

>> DIRECTION BUTTONS

The CPC has four direction buttons (3) in the center of the hand control which control the telescope's motion in altitude (up and down) and azimuth (left and right). The telescope can be controlled at nine different speed rates.

>> RATE BUTTON

Pressing the RATE key (11) allows you to instantly change the speed rate of the motors from high speed slew rate to precise guiding rate or anywhere in between. Each rate corresponds to a number on the hand controller key pad. The number 9 is the fastest rate (3° per second, depending on power source) and is used for slewing between objects and locating alignment stars. The number 1 on the hand control is the slowest rate (.5x sidereal) and can be used for accurate centering of objects in the eyepiece and photographic guiding. To change the speed rate of the motors:

- Press the RATE key on the hand control. The LCD will display the current speed rate.
- Press the number on the hand control that corresponds to the

desired speed. The number will appear in the upper-right corner of the LCD display to indicate that the rate has been changed.

The hand control has a "double button" feature that allows you to instantly speed up the motors without having to choose a speed rate. To use this feature, simply press the arrow button that corresponds to the direction that you want to move the telescope. While holding that button down, press the opposite directional button. This will increase the slew rate to the maximum slew rate.

When pressing the Up and Down arrow buttons in the slower slew rates (6 and lower) the motors will move the telescope in the opposite direction than the faster slew rates (7 thru 9). This is done so that an object will move in the appropriate direction when looking into the eyepiece (i.e. pressing the Up arrow button will move the star up in the field of view of the eyepiece). However, if any of the slower slew rates (rate 6 and below) are used to center an object in the finderscope, you may need to press the opposite directional button to make the telescope move in the correct direction.

1 = .5x*	4 = 8x	7 = .5° / sec
2 = 1x (sidereal)*	5 = 16x	8 = 2° / sec
3 = 4x	6 = 64x	9 = 4° / sec

NINE AVAILABLE SLEW SPEEDS

**Rate 1 and 2 are photographic guide rates and are meant to be used when the telescope is set up on a wedge in equatorial mode. These rates can be used while set up in altazimuth, however the actual speed rate may differ slightly.*

>> SETUP PROCEDURES

The CPC contains many user defined setup functions designed to give the user control over the telescope's many advanced features. All of the setup and utility features can be accessed by pressing the MENU key and scrolling through the options:

Tracking Mode – This allows you to change the way the telescope tracks depending on the type of mount being used to support the telescope. The CPC has three different tracking modes:

Alt-Az	This is the default tracking rate and is used when the telescope is placed on a flat surface or tripod without the use of an equatorial wedge. The telescope must be aligned with two stars before it can track in altazimuth (Alt-Az).
EQ North	Used to track the sky when the telescope is polar aligned using an equatorial wedge in the Northern Hemisphere.
EQ South	Used to track the sky when the telescope is polar aligned using an equatorial wedge in the Southern Hemisphere.
OFF	When using the telescope for terrestrial (land) observation, the tracking can be turned off so that the telescope never moves.

Tracking Rate – In addition to being able to move the telescope with the hand control buttons, the CPC will continually track a celestial object as it moves across the night sky. The tracking rate can be changed depending on what type of object is being observed:

Sidereal	This rate compensates for the rotation of the Earth by moving the telescope at the same rate as the rotation of the Earth, but in the opposite direction. When the telescope is polar aligned, this can be accomplished by moving the telescope in right ascension only. When mounted in Alt-Az mode, the telescope must make corrections in both R.A. and declination.
Lunar	Used for tracking the Moon when observing the lunar landscape.
Solar	Used for tracking the Sun when solar observing.

View Time-Site – Displays the current time and longitude/latitude downloaded from the GPS receiver. It will also display other relevant time-site information like time zone, daylight saving and local sidereal time. Local sidereal time (LST) is useful for knowing the right ascension of celestial objects that are located on the meridian at that time. View Time-Site will always display the last saved time and location entered while it is linking with the GPS. Once current information has been received, it will update the displayed information. If GPS is switched off, the hand control will only display the last saved time and location.

User Defined Objects – The CPC can store up to 400 different user defined objects in its memory. The objects can be daytime land objects or an interesting celestial object that you discover that is not included in the regular database. There are several ways to save an object to memory depending on what type of object it is:

Save Sky Object – The CPC stores celestial objects to its database by saving its right ascension and declination in the sky. This way the same object can be found each time the telescope is aligned. Once a desired object is centered in the eyepiece, simply scroll to the "**Save Sky Obj**" command and press ENTER. The display will ask you to enter a number between 1-200 to identify the object. Press ENTER again to save this object to the database.

Save Land Object – The CPC can also be used as a spotting scope on terrestrial objects. Fixed land objects can be stored by saving their altitude and azimuth relative to the location of the telescope at the time of observing. Since these objects are relative to the location of the telescope, they are only valid for that exact location. To save land objects, once again center the desired object in the eyepiece. Scroll down to the "**Save Land Obj**" command and press ENTER. The display will ask you to enter a number between 1-200 to identify the object. Press ENTER again to save this object to the database.

Save Database (Db) Object – This feature allows you to create your own custom tour of database objects by allowing you to record the current position of the telescope and save the name of the object by selecting it from any one of the database catalogs. These objects then can be accessed by selecting GoTo Sky Object.

Enter R.A. - Dec – You can also store a specific set of coordinates for an object just by entering the R.A. and declination for that object. Scroll to the "**Enter RA-DEC**" command and press ENTER. The display will then ask you to enter first the R.A. and then the declination of the desired object.

GoTo Object – To go to any of the user defined objects stored in the

database, scroll down to either **GoTo Sky Obj** or **GoTo Land Obj** and enter the number of the object you wish to select and press ENTER.

The CPC will automatically retrieve and display the coordinates before slewing to the object.

To replace the contents of any of the user defined objects, simply save a new object using one of the existing identification numbers. The CPC will replace the previous user defined object with the current one.

Get RA/DEC – Displays the right ascension and declination for the current position of the telescope.

GoTo R.A/Dec – Allows you to input a specific R.A. and declination and slew to it.

Identify

Identify Mode will search any of the CPC database catalogs or lists and display the name and offset distances to the nearest matching objects. This feature can serve two purposes. First, it can be used to identify an unknown object in the field of view of your eyepiece. Additionally, **Identify Mode** can be used to find other celestial objects that are close to the objects you are currently observing. For example, if your telescope is pointed at the brightest star in the constellation Lyra, choosing **Identify** and then searching the **Named Star** catalog will no doubt return the star Vega as the star you are observing. However, by selecting **Identify** and searching by the **Named Object** or **Messier** catalogs, the hand control will let you know that the Ring Nebula (M57) is approximately 6° from your current position. Searching the Double Star catalog will reveal that Epsilon Lyrae is only 1° away from Vega. To use the **Identify** feature:

- Press the MENU button and select the Identify option.
- Use the UP/DOWN scroll keys to select the catalog that you would like to search.
- Press ENTER to begin the search.

Note: Some of the databases contain thousands of objects, and can therefore take a minute or two to return the closest object.

Precise GoTo

The CPC has a Precise GoTo function that can assist in finding extremely faint objects and centering objects closer to the center of the field of view for astrophotography and CCD imaging. Precise GoTo automatically searches out the closest bright star to the desired object and asks the user to carefully center it in the eyepiece. The hand control then calculates the small difference between its GoTo position and its centered position. Using this offset, the telescope will then slew to the desired object with enhanced accuracy. To use Precise GoTo:

1. Press the MENU button and use the UP/DOWN keys to select **Precise GoTo**.
2. Choose **Database** to select the object that you want to observe from any of the database catalogs listed
3. Choose **RA/DEC** to enter a set of celestial coordinates that you wish to slew to.
4. Once the desired object is selected, the hand control will search out and display the closest bright star to your desired object. Press ENTER to slew to the bright alignment star.
5. Use the direction buttons to carefully center the alignment star in the eyepiece.

Press ENTER to slew to the desired object.

To store a set of coordinates (R.A./Dec) permanently into the CPC database, save it as a **User Defined Object** as described above.

>> SCOPE SETUP FEATURES

Setup Time-Site – Allows the user to customize the CPC display by changing time and location parameters (such as time zone and daylight savings).

Anti-backlash – All mechanical gears have a certain amount of backlash or play between the gears. This play is evident by how long it takes for a star to move in the eyepiece when the hand control arrow buttons are pressed (especially when changing directions). The CPC's anti-backlash feature allows the user to compensate for backlash by inputting a value which quickly rewinds the motors just enough to eliminate the play between gears. The amount of compensation needed depends on the slewing rate selected; the slower the slewing rate the longer it will take for the star to appear to move in the eyepiece. There are two values for each axis, positive and negative. Positive is the amount of compensation applied when you press the button, in order to get the gears moving quickly without a long pause. Negative is the amount of compensation applied when you release the button, winding the motors back in the other direction to resume tracking. You will need to experiment with different values (from 0-99); a value between 20 and 50 is usually best for most visual observing, whereas a higher value may be necessary for photographic guiding. Positive backlash compensation is applied when the mount changes its direction of movement from backwards to forwards. Similarly, negative backlash compensation is applied when the mount changes its direction of movement from forwards to backwards. When tracking is enabled, the mount will be moving in one or both axes in either the positive or negative direction, so backlash compensation will always be applied when a direction button is released and the direction moved is opposite to the direction of travel.

To set the anti-backlash value, scroll down to the *anti-backlash* option and press ENTER. While viewing an object in the eyepiece, observe the responsiveness of each of the four arrow buttons. Note which directions you see a pause in the star movement after the button has been pressed. Working one axis at a time, adjust the backlash settings high enough to cause immediate movement without resulting in a pronounced jump when pressing or releasing the button. Now, enter the same values for both positive and negative directions. If you notice a jump when releasing the button, but setting the values lower results in a pause when pressing the button, go with the higher value for positive, but use a lower value for negative. CPC will remember these values and use them each time it is turned on until they are changed.

Slew Limits – Sets the limits in altitude that the telescope can slew without displaying a warning message. By default the slew limits are set to 0° to 90° and will only display a warning message if an object is below the horizon. However, the slew limits can be customized depending on your needs. For example, if you have certain photographic accessories attached to your telescope preventing it from pointing straight-up, you can set the maximum altitude limit to read 80°, thus preventing the telescope from pointing to any objects that are greater than 80° in altitude without warning.

Slew limits are applied relative to the base of the mount not the actual horizon. So when setting the slew limits when using the telescope on an equatorial wedge, remember that a minimum slew limit of 0° would prevent the telescope from slewing down past the celestial equator not the horizon. To set the slew limit so that the telescope will slew to the horizon while on a wedge, you must set the minimum slew limit to equal your latitude minus 90°.

Filter Limits – When an alignment is complete, the CPC automatically knows which celestial objects are above the horizon. As a result, when

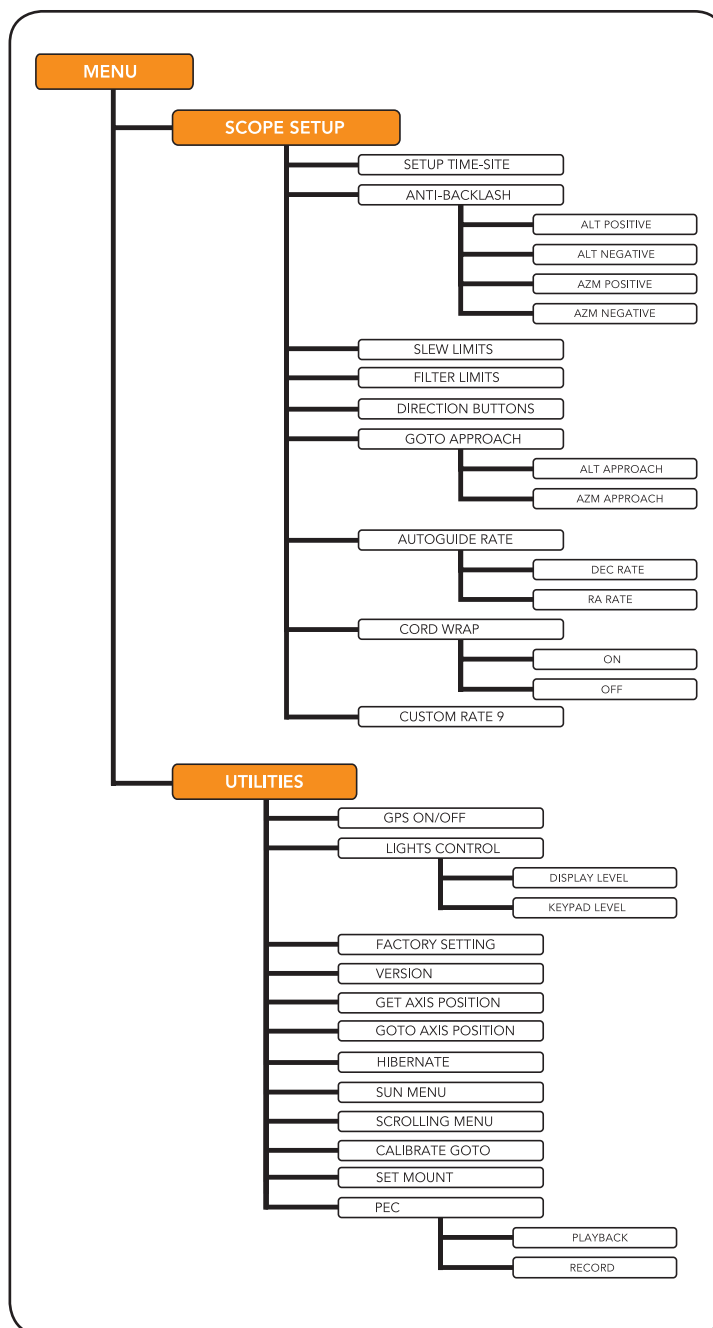

scrolling through the database lists (or selecting the Tour function), the CPC hand control will display only those objects that are known to be above the horizon when you are observing. You can customize the object database by selecting altitude limits that are appropriate for your location and situation. For example, if you are observing from a mountainous location where the horizon is partially obscured, you can set your minimum altitude limit to read +20°. This will make sure that the hand control only displays objects that are higher in altitude than 20°. If you manually enter an object that is below the horizon using the numeric keypad, the hand control will display a warning message before slewing to the object.

If you want to explore the entire object database, set the maximum altitude limit to 90° and the minimum limit to -90°. This will display every object in the database lists regardless of whether it is visible in the sky from your location.

Direction Buttons – The direction a star moves in the eyepiece varies depending on the accessories being used. This can create confusion when

guiding on a star using an off-axis guider versus a straight through guide scope. To compensate for this, the direction of the drive control keys can be changed. To reverse the button logic of the hand control, press the MENU button and select Direction Buttons from the Utilities menu. Use the UP/DOWN arrow keys (10) to select either the azimuth (left and right) or altitude (up and down) button direction and press ENTER. Pressing ENTER again will reverse the direction of the hand control buttons from their current state. Direction Buttons will only change the eyepiece rates (rate 1-6) and will not affect the slew rates (rate 7-9).

GoTo Approach – lets the user define the direction that the telescope will approach when slewing to an object. This allows the user the ability to minimize the effects of backlash. For example, if your telescope is back heavy from using heavy optical or photographic accessories attached to the back, you would want to set your altitude approach to the negative direction. This would ensure that the telescope always approaches an object from the opposite direction as the load pulling on the scope. Similarly, if using the CPC polar aligned on a wedge, you would want to set the azimuth approach to the direction that allows the scope to compensate for different load level on the motors and gears when pointing in different parts of the sky.

To change the GoTo approach direction, simply choose **GoTo Approach** from the **Scope Setup** menu, select either Altitude or Azimuth approach, choose positive or negative and press ENTER.

Autoguide Rate – Allows the user to set an autoguide rate as a percentage of sidereal rate. This is helpful when calibrating your telescope to a CCD autoguider for long exposure photography.

Cordwrap – Cord wrap safeguards against the telescope slewing more than 360° in azimuth and wrapping accessory cables around the base of the telescope. This is useful when autoguiding or any time that cables are plugged into the base of the telescope. By default, the cord wrap feature is turned off when the telescope is aligned in altazimuth and turned on when aligned on a wedge.

Custom Rate 9 – Allows the user to set the maximum slew speed when slewing to an object or pressing the arrow buttons while at rate 9. This provides more controlled slews when equipped with delicate imaging equipment for example. User defined rates can be set for both the RA and Dec axes. Enabling and disabling this feature will allow you to toggle back and forth between the custom setting and the default setting.

>> UTILITY FEATURES

Scrolling through the MENU (9) options will also provide access to several advanced utility functions within the CPC such as; Periodic Error Correction, Hibernate, as well as many others.

GPS On/Off – Allows you to turn off the GPS module. When aligning the telescope, the CPC still receives information, such as current time, from the GPS. If you want to use the CPC database to find the coordinates of a celestial object for a future date, you would need to turn the GPS module off in order to manually enter a date and time other than the present.

Lights Control – This feature allows you to turn off both the red key pad light and LCD display for daytime use to conserve power and to help preserve your night vision.

Factory Setting – Returns the CPC hand control to its original factory setting. Parameters such as backlash compensation values, initial date and time, longitude/latitude along with slew and filter limits will be reset. The hand control will ask you to press the “o” key before returning to the factory default setting.

Version – Selecting this option will allow you to see the current version number of the hand control and motor control software. The first set

of numbers indicates the hand control software version. For the motor control, the hand control will display two sets of numbers; the first numbers are for azimuth and the second set are for altitude.

Get Axis Position – Displays the relative altitude and azimuth for the current position of the telescope.

GoTo Axis Position – Allows you to enter a specific altitude and azimuth position and slew to it.

Hibernate – Hibernate allows the CPC to be completely powered down and still retain its alignment when turned back on. This not only saves power, but is ideal for those that have their telescopes permanently mounted or leave their telescope in one location for long periods of time. To place your telescope in Hibernate mode:

1. Select Hibernate from the Utility Menu.
2. Move the telescope to a desired position and press ENTER.
3. Power off the telescope. Remember to never move your telescope manually while in Hibernate mode.

Once the telescope is powered on again, the display will read Wake Up. After pressing ENTER, you have the option of scrolling through the time/site information to confirm the current setting. Press ENTER to wake up the telescope.

Pressing UNDO at the Wake Up screen allows you to explore many of the features of the hand control without waking the telescope up from Hibernate mode. To wake up the telescope after UNDO has been pressed, select Hibernate from the Utility menu and press ENTER. Do not use the direction buttons to move the telescope while in Hibernate mode.

Sun Menu

For safety purposes the Sun will not be displayed as a database object unless it is first enabled. To enable the Sun, go to the **Sun Menu** and press ENTER. The Sun will now be displayed in the Planets catalog and can be used as an alignment object when using the Solar System Alignment method. To remove the Sun from displaying on the hand control, once again select the Sun Menu from the Utilities Menu and press ENTER.

Scrolling Menu

This menu allows you to change the rate of speed that the text scrolls across the hand control display.

- Press the UP (number 6) button to increase the speed of the text.
- Press the DOWN (number 9) button to decrease the speed of the text.

Calibrate GoTo – GoTo Calibration is a useful tool when attaching heavy visual or photographic accessories to the telescope. GoTo Calibration calculates the amount of distance and time it takes for the mount to complete its final slow GoTo when slewing to an object. Changing the balance of the telescope can prolong the time it takes to complete the final slew. GoTo Calibration takes into account any slight imbalances and changes the final GoTo distance to compensate.

Set Mount Position

The Set Mount Position menu can be used to maintain your alignment in cases where you wish to disengage the clutches or similar situations. For instance, you might use this feature if you needed to rebalance the mount after having completed an alignment. To set the mount position simply slew to a bright star in the named star list then select **Set Mount Position**. The hand control will sync on the star by asking you to center the star in the eyepiece and pressing the **Align** button. Once synced on the star, you are free to manually move the mount in both axes in order

to rebalance. When you are ready to slew the telescope to your next object, just remember to manually return the tube to the same bright star and carefully center it in the eyepiece. Using this tool will invalidate the PEC index

Periodic Error Correction (PEC) – PEC is designed to improve photographic quality by reducing the amplitude of the worm gear errors

and improving the tracking accuracy of the drive. This feature is for advanced astrophotography and is used when your telescope is polar aligned with the optional equatorial wedge. For more information on using PEC, see the section on "**Celestial Photography**".

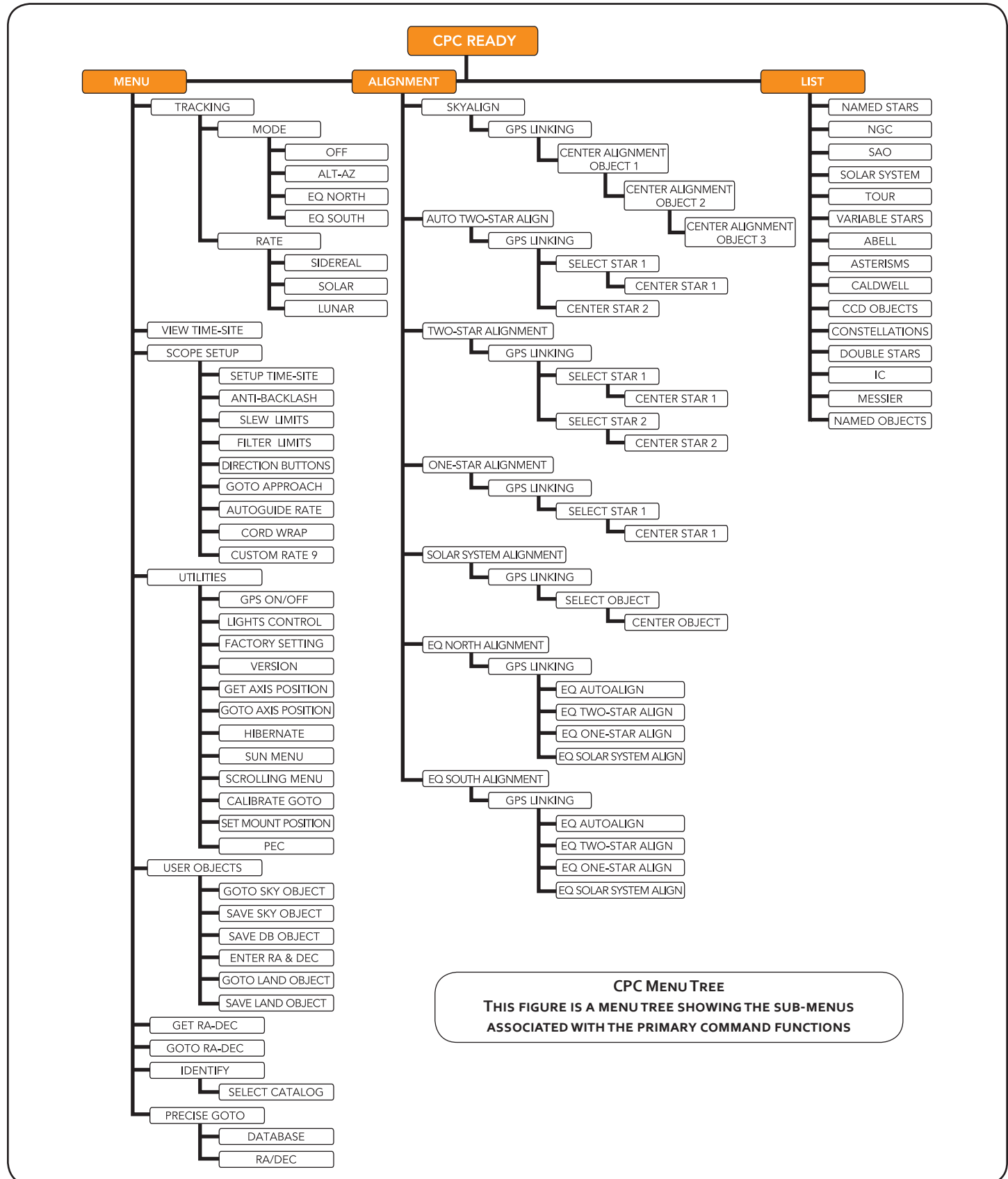

CPC MENU TREE
THIS FIGURE IS A MENU TREE SHOWING THE SUB-MENUS ASSOCIATED WITH THE PRIMARY COMMAND FUNCTIONS

TELESCOPE BASICS

A telescope is an instrument that collects and focuses light. The nature of the optical design determines how the light is focused. Some telescopes, known as refractors, use lenses. Other telescopes, known as reflectors, use mirrors. The EdgeHD optical system (Aplanatic Schmidt) uses a combination of mirrors and lenses and is referred to as a compound or catadioptric telescope. This unique design offers large-diameter optics while maintaining very short tube lengths, making them extremely portable. The EdgeHD system consists of a zero power corrector plate, a spherical primary mirror, and a secondary mirror along with a set of field flattening lens integrated into the baffle tube. Once light rays enter the optical system, they travel the length of the optical tube three times.

The optics of an EdgeHD telescope has StarBright XLT coatings – enhanced multi-layer coatings on the primary and secondary mirrors for increased reflectivity and a fully coated corrector for the finest anti-reflection characteristics.

Inside the optical tube, a black tube extends out from the center hole in the primary mirror. This is the primary baffle tube, and it prevents stray light from passing through to the eyepiece or camera.

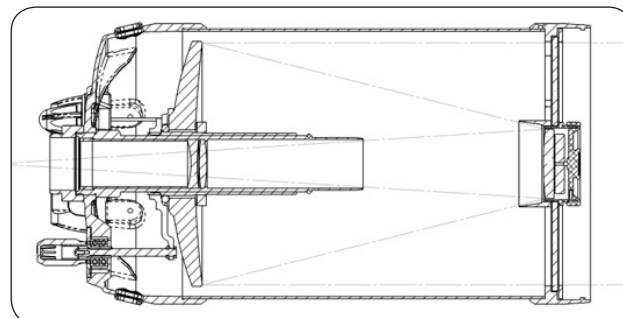

FIGURE 5-1

A CUTAWAY VIEW OF THE LIGHT PATH OF THE EDGEHD OPTICAL

>> IMAGE ORIENTATION

The image orientation changes depending on how the eyepiece is inserted into the telescope. When using the star diagonal, the image is right-side-up, but reversed from left-to-right (i.e., mirror image).

If inserting the eyepiece directly into the visual back (i.e., without the star diagonal), the image is upside-down and reversed from left-to-right (i.e., inverted). This is normal for the Schmidt-Cassegrain design.



ACTUAL IMAGE ORIENTATION AS SEEN WITH THE UNAIDED EYE



REVERSED FROM LEFT TO RIGHT, AS VIEWED WITH A STAR DIAGONAL



INVERTED IMAGE, AS VIEWED WITH THE EYEPIECE DIRECTLY IN TELESCOPE

FIGURE 5-2

>> FOCUSING

The CPC's focusing mechanism controls the primary mirror which is mounted on a ring that slides back and forth on the primary baffle tube. The focusing knob, which moves the primary mirror, is on the rear cell of the telescope just below the star diagonal and eyepiece. Turn the focusing knob until the image is sharp. If the knob will not turn, it has reached the end of its travel on the focusing mechanism. Turn the knob in the opposite direction until the image is sharp. Once an image is in focus, turn the knob clockwise to focus on a closer object and counterclockwise for a more distant object. A single turn of the focusing knob moves the primary mirror only slightly. Therefore, it will take many turns (about 30) to go from close focus (approximately 60 feet) to infinity.

For astronomical viewing, out of focus star images are very diffuse, making them difficult to see. If you turn the focus knob too quickly, you can go right through focus without seeing the image. To avoid this problem, your first astronomical target should be a bright object (like the Moon or a planet) so that the image is visible even when out of focus.

Critical focusing is best accomplished when the focusing knob is turned

in such a manner that the mirror moves against the pull of gravity. In doing so, any mirror shift is minimized. For astronomical observing, both visually and photographically, this is done by turning the focus knob counterclockwise.

THE EMBLEM ON THE END OF THE FOCUS KNOB SHOWS THE CORRECT ROTATIONAL DIRECTION FOR FOCUSING THE CPC.

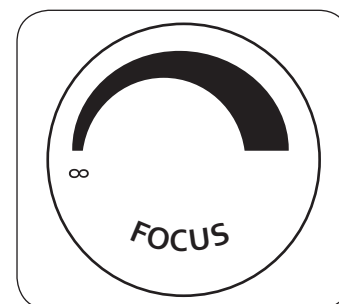

FIGURE 5-3

>> MIRROR SUPPORT CLUTCHES

The EdgeHD Optical tube is equipped with mirror tension clutches to help support and minimize lateral movement of the primary mirror during astrophotography.

To use the mirror clutches:

1. Use the focus knob to adjust the primary mirror to the desired focus.
2. Once in focus, turn the two mirror lock knobs clockwise until both are very tight and can be turned no further.

Warning! *Once the mirror is locked down, do not turn the focuser knob without loosening the mirror locks first. Although turning the focus knob should not damage the telescope, undue stress can be placed on the focus mechanisms causing excessive image shift while focusing.*



FIGURE 5-4

>> CALCULATING MAGNIFICATION

You can change the power of your telescope just by changing the eyepiece (ocular). To determine the magnification of your telescope, simply divide the focal length of the telescope by the focal length of the eyepiece used. In equation format, the formula looks like this:

$$\text{MAGNIFICATION} = \frac{\text{Focal Length of Telescope (mm)}}{\text{Focal Length of Eyepiece (mm)}}$$

Let's say, for example, you are using the 40 mm Plössl eyepiece. To determine the magnification you simply divide the focal length of your

telescope (the CPC 800, for example, has a focal length of 2032 mm) by the focal length of the eyepiece, 40 mm. Dividing 2032 by 40 yields a magnification of 51 power.

Although the power is variable, each instrument under average skies has a limit to the highest useful magnification. The general rule is that 60 power can be used for every inch of aperture. For example, the CPC 800 is 8 inches in diameter. Multiplying 8 by 60 gives a maximum useful magnification of 480 power. Although this is the maximum useful magnification, most observing is done in the range of 20 to 35 power for every inch of aperture which is 160 to 280 times for the CPC 800 telescope.

>> DETERMINING FIELD OF VIEW

Determining the field of view is important if you want to get an idea of the angular size of the object you are observing. To calculate the actual field of view, divide the apparent field of the eyepiece (supplied by the eyepiece manufacturer) by the magnification. In equation format, the formula looks like this:

$$\text{TRUE FIELD} = \frac{\text{Apparent Field of Eyepiece}}{\text{Magnification}}$$

As you can see, before determining the field of view, you must calculate the magnification. Using the example in the previous section, we can

determine the field of view using the same 40 mm eyepiece. The 40 mm Plössl eyepiece has an apparent field of view of 46°. Divide the 46° by the magnification, which is 51 power. This yields an actual field of .9°, or almost a full degree.

To convert degrees to feet at 1,000 yards, which is more useful for terrestrial observing, simply multiply by 52.5. Continuing with our example, multiply the angular field .9° by 52.5. This produces a linear field width of 47 feet at a distance of one thousand yards. The apparent field of each eyepiece that Celestron manufactures is found in the Celestron Accessory Catalog (#93685).

>> GENERAL OBSERVING HINTS

When working with any optical instrument, there are a few things to remember to ensure you get the best possible image.

- Never look through window glass. Glass found in household windows is optically imperfect, and as a result, may vary in thickness from one part of a window to the next. This inconsistency can and will affect the ability to focus your telescope. In most cases you will not be able to achieve a truly sharp image, while in some cases, you may actually see a double image.
- Never look across or over objects that are producing heat waves. This includes asphalt parking lots on hot summer days or building rooftops.
- Hazy skies, fog and mist can also make it difficult to focus when viewing terrestrially. The amount of detail seen under these conditions is greatly reduced. Also, when photographing under these conditions, the processed film may come out a little grainier than normal with lower contrast and underexposed.
- If you wear corrective lenses (specifically glasses), you may want to remove them when observing with an eyepiece attached to the telescope. When using a camera, however, you should always wear corrective lenses to ensure the sharpest possible focus. If you have a stigmatism, corrective lenses must be worn at all times.

ASTRONOMY BASICS

Up to this point, this manual covered the assembly and basic operation of your CPC telescope. However, to understand your telescope more thoroughly, you need to know a little about the night sky. This section

deals with observational astronomy in general and includes information on the night sky and polar alignment.

>> THE CELESTIAL COORDINATE SYSTEM

To help find objects in the sky, astronomers use a celestial coordinate system that is similar to our geographical coordinate system here on Earth. The celestial coordinate system has poles, lines of longitude and latitude and an equator. For the most part, these remain fixed against the background stars.

The celestial equator runs 360 degrees around the Earth and separates the northern celestial hemisphere from the southern. Like the Earth's equator, it bears a reading of zero degrees. On Earth this would be latitude. However, in the sky this is referred to as declination, or DEC for short. Lines of declination are named for their angular distance above and below the celestial equator. The lines are broken down into degrees, minutes of arc and seconds of arc. Declination readings south of the equator carry a minus sign (-) in front of the coordinate and those north of the celestial equator are either blank (i.e., no designation) or preceded by a plus sign (+).

The celestial equivalent of longitude is called Right Ascension, or R.A. for short. Like the Earth's lines of longitude, they run from pole to pole and are evenly spaced 15 degrees apart. Although the longitude lines are separated by an angular distance, they are also a measure of time. Each line of longitude is one hour apart from the next. Since the Earth rotates once every 24 hours, there are 24 lines total. As a result, the R.A. coordinates

are marked off in units of time. It begins with an arbitrary point in the constellation of Pisces designated as 0 hours, 0 minutes, 0 seconds. All other points are designated by how far (i.e., how long) they lag behind this coordinate after it passes overhead moving toward the west.

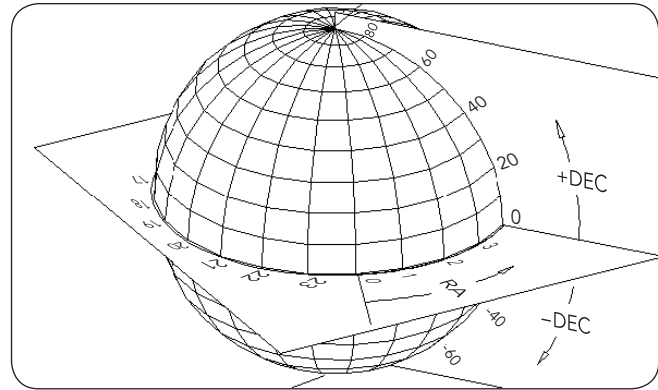

FIGURE 6-1

THE CELESTIAL SPHERE SEEN FROM THE OUTSIDE SHOWING R.A. AND DEC

>> MOTION OF THE STARS

The daily motion of the Sun across the sky is familiar to even the most casual observer. This daily trek is not the Sun moving as early astronomers thought, but the result of the Earth's rotation. The Earth's rotation also causes the stars to do the same, scribing out a large circle as the Earth completes one rotation. The size of the circular path a star follows depends on where it is in the sky. Stars near the celestial equator form the largest circles rising in the east and setting in the west. Moving toward the north celestial pole, the point around which the stars in the northern hemisphere appear to rotate, these circles become smaller. Stars in the mid-celestial latitudes rise in the northeast and set in the

northwest. Stars at high celestial latitudes are always above the horizon, and are said to be circumpolar because they never rise and never set. You will never see the stars complete one circle because the sunlight during the day washes out the starlight. However, part of this circular motion of stars in this region of the sky can be seen by setting up a camera on a tripod and opening the shutter for a couple hours. The processed film will reveal semicircles that revolve around the pole. (This description of stellar motions also applies to the southern hemisphere except all stars south of the celestial equator move around the south celestial pole.)

STARS SEEN NEAR THE NORTH CELESTIAL POLE

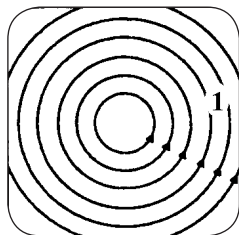

STARS SEEN NEAR THE CELESTIAL EQUATOR

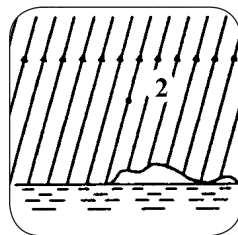

STARS SEEN LOOKING IN THE OPPOSITE DIRECTION OF THE NORTH CELESTIAL POLE

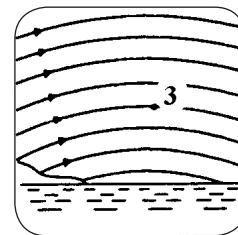

FIGURE 6-2

ALL STARS APPEAR TO ROTATE AROUND THE CELESTIAL POLES. HOWEVER, THE APPEARANCE OF THIS MOTION VARIES DEPENDING ON WHERE YOU ARE LOOKING IN THE SKY. NEAR THE NORTH CELESTIAL POLE, THE STARS SCRIBE OUT RECOGNIZABLE CIRCLES CENTERED ON THE POLE (1). STARS NEAR THE CELESTIAL EQUATOR ALSO FOLLOW CIRCULAR PATHS AROUND THE POLE. BUT, THE COMPLETE PATH IS INTERRUPTED BY THE HORIZON. THESE APPEAR TO RISE IN THE EAST AND SET IN THE WEST (2). LOOKING TOWARD THE OPPOSITE POLE, STARS CURVE OR ARC IN THE OPPOSITE DIRECTION SCRIBING A CIRCLE AROUND THE OPPOSITE POLE (3).

>> POLAR ALIGNMENT (WITH OPTIONAL WEDGE)

Even though the CPC can precisely track a celestial object while in the Alt-Az position, it is still necessary to align the polar axis of the telescope (the fork arm) to the Earth's axis of rotation in order to do long exposure astrophotography. To do an accurate polar alignment, the CPC requires an optional equatorial wedge between the telescope and the tripod. This allows the telescope's tracking motors to rotate the telescope around the celestial pole, the same way as the stars. Without the equatorial wedge, you would notice the stars in the eyepiece would slowly rotate around the center of the field of view. Although this gradual rotation would go unnoticed when viewing with an eyepiece, it would be very noticeable when imaging.

Polar alignment is the process by which the telescope's axis of rotation (called the polar axis) is aligned (made parallel) with the Earth's axis of rotation. Once aligned, a telescope with a clock drive will track the stars as they move across the sky. The result is that objects observed through the telescope appear stationary (i.e., they will not drift out of the field of view). If not using the clock drive, all objects in the sky (day or night) will slowly drift out of the field. This motion is caused by the Earth's rotation.

>> ALL-STAR POLAR ALIGNMENT

The CPC hand control has a polar alignment function called "All-Star" polar alignment that will help you polar align your telescope for increased tracking precision and astrophotography. This feature allows you to choose any bright alignment stars to assist in accurately aligning your telescope and wedge with the North Celestial Pole. Before using the Polar Align feature, you must first perform an EQ North or South Alignment.

Once your telescope is EQ aligned, slew the telescope to any bright star in its Named Star database list. This will be the star used for the All-Star Polar Alignment. For best results, it is always good to choose a polar alignment star that is high in the sky and near the Meridian. Try to avoid stars that are close to the west/east horizon, directly overhead or too near the celestial pole.

Press the Align button and use the Up/Down buttons on the hand controller to select Polar Align from the list.

The Polar Align feature has two options: *Align Wedge* and *Display Align*.

Align Wedge – After performing an EQ North or South Alignment and slewing your telescope to any bright star in the telescope's database, select the "Align Wedge" option. The telescope will then re-slew to the same star.

1. Center the star in the finderscope and press ENTER.
2. Then accurately center the star in your eyepiece and press ALIGN. The telescope will then "sync" on this star and slew to the position that the star should be if it were accurately polar aligned.

For the most accurate alignment it is best to use a reticle eyepiece (see *Optional Accessories*) or a high power eyepiece to precisely center the star in the field of view.

3. Use the wedges latitude and azimuth adjustments to place the star in the center of the eyepiece. **Do not use the direction buttons on the hand control to position the star.** Once the star is centered in the eyepiece, press ENTER; the polar axis should now be pointed towards the North Celestial Pole.

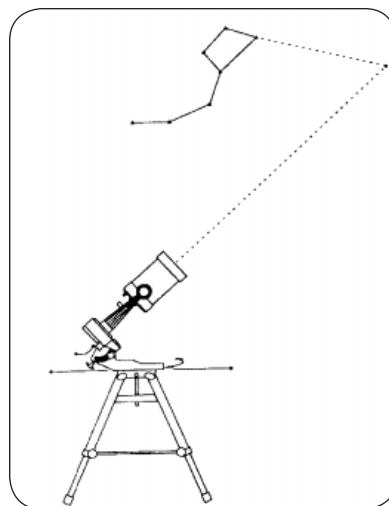

FIGURE 6-3

THIS IS HOW THE TELESCOPE IS TO BE SET UP FOR POLAR ALIGNMENT. THE TUBE SHOULD BE PARALLEL TO THE FORK ARM AND THE MOUNT SHOULD POINT TO POLARIS.

Updating your Star Alignment

After polar alignment, it's a good idea to check the pointing accuracy of the telescope to see how much it may have been affected by moving the mount. Since the polar alignment process requires you to "sync" the telescope on a bright star before you begin, it will be necessary to undo the sync before re-aligning. To undo the sync:

1. Press the *Align* button and use the UP/DOWN buttons on the hand controller to select *Undo Sync* from the list, and press *Enter*. The message *Complete* will display on the LCD.

To re-align your telescope:

2. Slew the telescope to one of the original alignment stars, or another bright star if the original alignment stars are no longer in a convenient location. Press the *Align* button and use the UP/DOWN buttons on the hand controller to select *Alignment Stars* from the list.
3. The hand control will ask you which of the original alignment stars you wish to replace. Use the UP/DOWN buttons to select the desired star and press *Enter*.
4. Once again, center the star in the finderscope and press *Enter*.
5. Then center the star in the eyepiece and Press *Align*.
6. Repeat the process on a second alignment star.

Display Align – the user can now display the polar alignment error in the RA and DEC axes. These values show how close the mount is pointed at the celestial pole based on how accurately the user centered the alignment star with the hand control and with the mount adjustment. To display the alignment error:

1. Press the *Align* button and use the UP/DOWN buttons on the hand controller to select *Display Align* from the list, and press *Enter*.

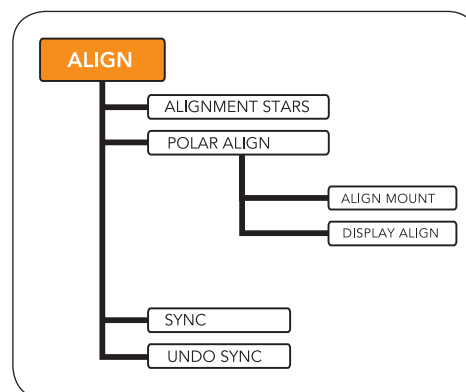

>> FINDING THE NORTH CELESTIAL POLE

In each hemisphere, there is a point in the sky around which all the other stars appear to rotate. These points are called the celestial poles and are named for the hemisphere in which they reside. For example, in the northern hemisphere all stars move around the north celestial pole. When the telescope's polar axis is pointed at the celestial pole, it is parallel to the Earth's rotational axis.

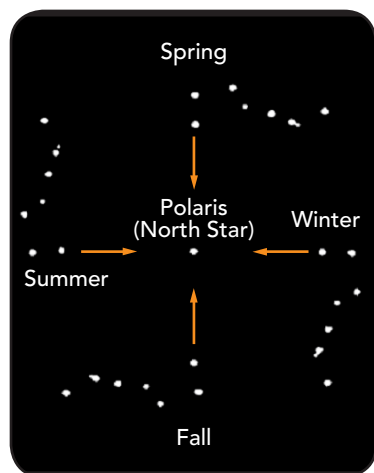

FIGURE 6-5

THE POSITION OF THE BIG DIPPER CHANGES THROUGHOUT THE YEAR AND THE NIGHT.

Many methods of polar alignment require that you know how to find the celestial pole by identifying stars in the area. For those in the northern hemisphere, finding the celestial pole is not too difficult. Fortunately, we have a naked eye star less than a degree away. This star, Polaris, is the end star in the handle of the Little Dipper. Since the Little Dipper (technically called Ursa Minor) is not one of the brightest constellations in the sky, it may be difficult to locate from urban areas. If this is the case, use the two end stars in the bowl of the Big Dipper (the pointer stars). Draw an imaginary line through them toward the Little Dipper. They point to Polaris (see Figure 6-6). The position of the Big Dipper changes during the year and throughout the course of the night (see Figure 6-5). When the Big Dipper is low in the sky (i.e., near the horizon), it may be difficult to locate. During these times, look for Cassiopeia (see Figure 6-6). Observers in the southern hemisphere are not as fortunate as those in the northern hemisphere. The stars around

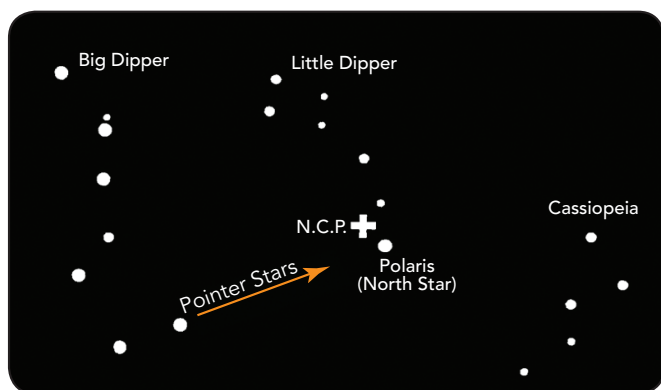

FIGURE 6-6

THE TWO STARS IN THE FRONT OF THE BOWL OF THE BIG DIPPER POINT TO POLARIS WHICH IS LESS THAN ONE DEGREE FROM THE TRUE (NORTH) CELESTIAL POLE. CASSIOPEIA, THE "W" SHAPED CONSTELLATION, IS ON THE OPPOSITE SIDE OF THE POLE FROM THE BIG DIPPER. THE NORTH CELESTIAL POLE (N.C.P.) IS MARKED BY THE "+" SIGN.

the south celestial pole are not nearly as bright as those around the north. The closest star that is relatively bright is Sigma Octantis. This star is just within naked eye limit (magnitude 5.5) and lies about 59 arc minutes from the pole.

The north celestial pole is the point in the northern hemisphere around which all stars appear to rotate. The counterpart in the southern hemisphere is referred to as the south celestial pole.

Declination Drift Method of Polar Alignment

This method of polar alignment allows you to get the most accurate alignment on the celestial pole and is required if you want to do long exposure deep-sky astrophotography through the telescope. The declination drift method requires that you monitor the drift of selected stars. The drift of each star tells you how far away the polar axis is pointing from the true celestial pole and in what direction. Although declination drift is simple and straight-forward, it requires a great deal of time and patience to complete when first attempted. The declination drift method should be done after any one of the previously mentioned methods has been completed.

To perform the declination drift method you need to choose two bright stars. One should be near the eastern horizon and one due south near the meridian. Both stars should be near the celestial equator (i.e., 0° declination). You will monitor the drift of each star one at a time and in declination only. While monitoring a star on the meridian, any misalignment in the east-west direction is revealed. While monitoring a star near the east/west horizon, any misalignment in the north-south direction is revealed. It is helpful to have an illuminated reticle eyepiece to help you recognize any drift. For very close alignment, a Barlow lens is also recommended since it increases the magnification and reveals any drift faster. When looking due south, insert the diagonal so the eyepiece points straight up. Insert the cross hair eyepiece and align the cross hairs so that one is parallel to the declination axis and the other is parallel to the right ascension axis. Move your telescope manually in R.A. and DEC to check parallelism.

First, choose your star near where the celestial equator and the meridian meet. The star should be approximately within 1/2 an hour of the meridian and within five degrees of the celestial equator. Center the star in the field of your telescope and monitor the drift in declination.

- If the star drifts south, the polar axis is too far east.
- If the star drifts north, the polar axis is too far west.

Make the appropriate adjustments to the polar axis to eliminate any drift. Once you have eliminated all the drift, move to the star near the eastern horizon. The star should be 20 degrees above the horizon and within five degrees of the celestial equator.

- If the star drifts south, the polar axis is too low.
- If the star drifts north, the polar axis is too high.

Again, make the appropriate adjustments to the polar axis to eliminate any drift. Unfortunately, the latter adjustments interact with the prior adjustments ever so slightly. So, repeat the process again to improve the accuracy checking both axes for minimal drift. Once the drift has been eliminated, the telescope is very accurately aligned. You can now do prime focus deep-sky astrophotography for long periods.

NOTE: If the eastern horizon is blocked, you may choose a star near the western horizon, but you must reverse the polar high/low error directions. Also, if using this method in the southern hemisphere, the direction of drift is reversed for both R.A. and DEC.

CELESTIAL OBSERVING

With your telescope set up, you are ready to use it for observing. This section covers visual observing hints for both solar system and deep

sky objects as well as general observing conditions which will affect your ability to observe.

>> OBSERVING THE MOON

Often, it is tempting to look at the Moon when it is full. At this time, the face we see is fully illuminated and its light can be overpowering. In addition, little or no contrast can be seen during this phase.

One of the best times to observe the Moon is during its partial phases (around the time of first or third quarter). Long shadows reveal a great amount of detail on the lunar surface. At low power you will be able to see most of the lunar disk at one time. The optional Reducer/Corrector lens allows for breath-taking views of the entire lunar disk when used with a low power eyepiece. Change to higher power (magnification) to focus in on a smaller area. Choose the lunar tracking rate from the CPC's MENU tracking rate options to keep the Moon centered in the eyepiece even at high magnifications.

Lunar Observing Hints

To increase contrast and bring out detail on the lunar surface, use filters. A yellow filter works well at improving contrast while a neutral density or polarizing filter will reduce overall surface brightness and glare.



>> OBSERVING THE PLANETS

Other fascinating targets include the five naked eye planets. You can see Venus go through its lunar-like phases. Mars can reveal a host of surface detail and one, if not both, of its polar caps. You will be able to see the cloud belts of Jupiter and the Great Red Spot (if it is visible at the time you are observing). In addition, you will also be able to see the moons of Jupiter as they orbit the giant planet. Saturn, with its beautiful rings, is easily visible at moderate power.

Planetary Observing Hints

- Remember that atmospheric conditions are usually the limiting factor on how much planetary detail will be visible. So, avoid observing the planets when they are low on the horizon or when they are directly over a source of radiating heat, such as a rooftop or chimney. See "Seeing Conditions" later in this section.
- To increase contrast and bring out detail on the planetary surface, try using Celestron eyepiece filters.



>> OBSERVING THE SUN

Although overlooked by many amateur astronomers, solar observation is both rewarding and fun. However, because the Sun is so bright, special precautions must be taken when observing our star so as not to damage your eyes or your telescope.

Never project an image of the Sun through the telescope. Because of the folded optical design, tremendous heat build-up will result inside the optical tube. This can damage the telescope and/or any accessories attached to the telescope.

For safe solar viewing, use a solar filter that reduces the intensity of the Sun's light, making it safe to view. With a filter you can see sunspots as

they move across the solar disk and faculae, which are bright patches seen near the Sun's edge.

Solar Observing Hints

- The best time to observe the Sun is in the early morning or late afternoon when the air is cooler.
- To center the Sun without looking into the eyepiece, watch the shadow of the telescope tube until it forms a circular shadow.
- To ensure accurate tracking, be sure to select the solar tracking rate.

>> OBSERVING DEEP SKY OBJECTS

Deep-sky objects are simply those objects outside the boundaries of our solar system. They include star clusters, planetary nebulae, diffuse nebulae, double stars and other galaxies outside our own Milky Way. Most deep-sky objects have a large angular size. Therefore, low-to-moderate power is all you need to see them. Visually, they are too faint to reveal any of the color seen in long exposure photographs. Instead,

they appear black and white. And, because of their low surface brightness, they should be observed from a dark-sky location. Light pollution around large urban areas washes out most nebulae making them difficult, if not impossible, to observe. Light Pollution Reduction filters help reduce the background sky brightness, thus increasing contrast.

>> SEEING CONDITIONS

Viewing conditions affect what you can see through your telescope during an observing session. Conditions include transparency, sky illumination

and seeing. Understanding viewing conditions and the effect they have on observing will help you get the most out of your telescope.

>> TRANSPARENCY

Transparency is the clarity of the atmosphere which is affected by clouds, moisture and other airborne particles. Thick cumulus clouds are completely opaque while cirrus can be thin, allowing the light from the brightest stars through. Hazy skies absorb more light than clear skies

making fainter objects harder to see and reducing contrast on brighter objects. Aerosols ejected into the upper atmosphere from volcanic eruptions also affect transparency. Ideal conditions are when the night sky is inky black.

>> SKY ILLUMINATION

General sky brightening caused by the Moon, aurorae, natural airglow and light pollution greatly affect transparency. While not a problem for the brighter stars and planets, bright skies reduce the contrast of extended nebulae making them difficult, if not impossible to see. To maximize your observing, limit deep sky viewing to moonless nights far from the light

polluted skies found around major urban areas. LPR filters enhance deep sky viewing from light polluted areas by blocking unwanted light while transmitting light from certain deep sky objects. You can, on the other hand, observe planets and stars from light polluted areas or when the Moon is out.

>> SEEING

Seeing conditions refers to the stability of the atmosphere and directly affects the amount of fine detail seen in extended objects. The air in our atmosphere acts as a lens which bends and distorts incoming light rays. The amount of bending depends on air density. Varying temperature layers have different densities and, therefore, bend light differently. Light rays from the same object arrive slightly displaced creating an imperfect or smeared image. These atmospheric disturbances vary from

time-to-time and place-to-place. The size of the air parcels compared to your aperture determines the "seeing" quality. Under good seeing conditions, fine detail is visible on the brighter planets like Jupiter and Mars, and stars are pinpoint images. Under poor seeing conditions, images are blurred and stars appear as blobs.

The conditions described here apply to both visual and photographic observations.

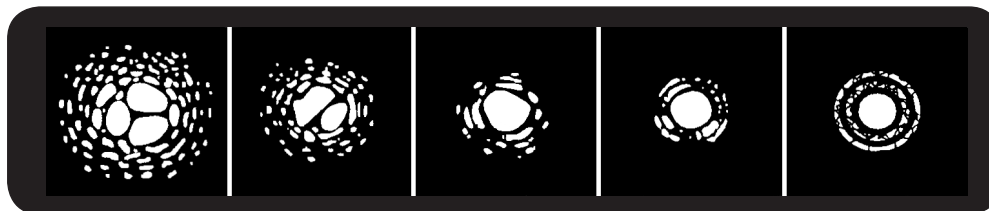

FIGURE 7-1

SEEING CONDITIONS DIRECTLY AFFECT IMAGE QUALITY. THESE DRAWING REPRESENT A POINT SOURCE (I.E., STAR) UNDER BAD SEEING CONDITIONS (LEFT) TO EXCELLENT CONDITIONS (RIGHT). MOST OFTEN, SEEING CONDITIONS PRODUCE IMAGES THAT LIE SOME WHERE BETWEEN THESE TWO EXTREMES.

CELESTIAL PHOTOGRAPHY

After looking at the night sky for a while, you may want to try photographing it. Several forms of celestial photography are possible with your telescope, including short exposure prime focus, eyepiece projection, long exposure deep sky, terrestrial and even CCD imaging. Each of these is discussed in moderate detail with enough information to get you started. Topics include the accessories required and some simple techniques. More information is available in some of the publications listed at the end of this manual.

In addition to the specific accessories required for each type of celestial photography, there is the need for a camera – but not just any camera. The camera does not have to have many of the features offered on today’s state-of-the-art equipment. For example, you don’t need auto focus capability or mirror lock up. Here are the mandatory features a camera needs for celestial photography. First, a “B” setting is required which allows for time exposures. This excludes point and shoot cameras and limits the selection to SLR cameras, the most common type of 35 mm camera on the market today.

>> SHORT EXPOSURE PRIME FOCUS PHOTOGRAPHY

Short exposure prime focus photography is the best way to begin recording celestial objects. It is done with the camera attached to the telescope without an eyepiece or camera lens in place. To attach your camera you need the Celestron T-Adapter (See Optional Accessories section) and a T-Ring for your specific camera (i.e., Canon, Nikon, etc.). The T-Ring replaces the 35 mm SLR camera’s normal lens. Prime focus photography allows you to capture the majority of the lunar or solar disk. To attach your camera to your telescope:

1. Remove all visual accessories. (For the 9.25” and 11” tube you must also remove the 3” adapter plate threaded onto the rear of the tube)
2. Thread the T-Ring onto the T-Adapter.
3. Mount your camera body onto the T-Ring the same as you would for a standard camera lens.
4. Thread the T-Adapter onto the back of the telescope while holding the camera in the desired orientation (either vertical or horizontal).

With your camera attached to the telescope, you are ready for prime focus photography. Start with an easy object like the Moon. Here’s how to do it:

1. Center the Moon in the field of your telescope.
2. Focus the telescope by turning the focus knob until the image is sharp. Make sure the mirror lock knobs are loosened.
3. Set the shutter speed to the appropriate setting (see Figure 8-1).
4. Trip the shutter using a cable release or self timer.
5. Use your camera’s bracketing feature to automatically change exposure time in order to find the best exposure.

The exposure times listed in table 8-1 should be used as a starting point. Always make exposures that are longer and shorter than the recommended time. Also, take a few photos at each shutter speed. This will ensure that you will get a good photo.

- This technique is also used for photographing the Sun with the proper solar filter.

Second, the “B” or manual setting should NOT run off the battery. Many new electronic cameras use the battery to keep the shutter open during time exposures. Once the batteries are drained, usually after a few minutes, the shutter closes, whether you were finished with the exposure or not. Look for a camera that has a manual shutter when operating in the time exposure mode. Olympus, Nikon, Minolta, Pentax, Canon and others have made such camera bodies.

The camera must have interchangeable lenses so you can attach it to the telescope and use a variety of lenses for piggyback photography. If you can’t find a new camera, you can purchase a used camera body that is not 100% functional. The light meter, for example, does not have to be operational since you will be determining the exposure length manually.

You will also need a cable release with a locking function to hold the shutter open. Mechanical and air release models are available.

Lunar Phase	ISO 50	ISO 100	ISO 200	ISO 400
Crescent	1/2	1/4	1/8	1/15
Quarter	1/15	1/30	1/60	1/125
Full	1/30	1/60	1/125	1/250

FIGURE 8-1

ABOVE IS A LISTING OF RECOMMENDED EXPOSURE TIMES WHEN PHOTOGRAPHING THE MOON AT THE PRIME FOCUS OF YOUR TELESCOPE.

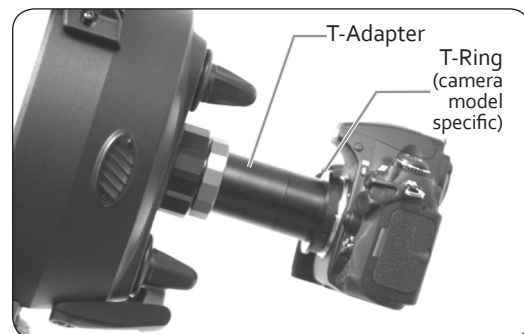

FIGURE 8-2a

T-ADAPTER FOR 8” OPTICAL TUBE

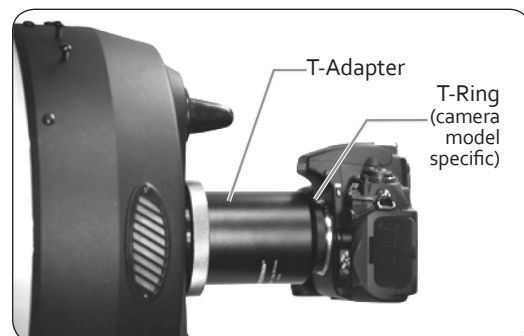

FIGURE 8-2b

T-ADAPTER FOR 11/14” OPTICAL TUBE

>> EYEPIECE PROJECTION

This form of celestial photography is designed for objects with small angular sizes, primarily the Moon and planets. Planets, although physically quite large, appear small in angular size because of their great distances. Moderate to high magnification is, therefore, required to make the image large enough to see any detail. Unfortunately, the camera/telescope combination alone does not provide enough magnification to produce a usable image size on film. In order to get the image large enough, you must attach your camera to the telescope with the eyepiece in place. To do so, you need two additional accessories; a deluxe tele-extender (#93643), which attaches to the visual back and a T-ring for your particular camera make (i.e., Minolta, Nikon, Pentax, etc.). Because of the high magnifications during eyepiece projection, the field of view is quite small which makes it difficult to find and center objects. To make the job a little easier, align the finder as accurately as possible. This allows you to get the object in the telescope's field based on the finder's view alone.

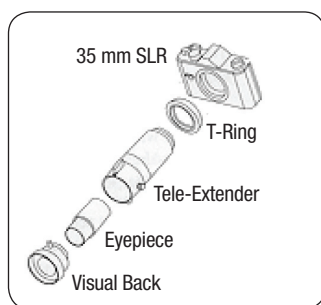

FIGURE 8-3

ACCESSORIES FOR PROJECTION PHOTOGRAPHY

Another problem introduced by the high magnification is vibration. Simply tripping the shutter – even with a cable release – produces enough vibration to smear the image. To get around this, use the camera's self-timer if the exposure time is less than one second – a common occurrence when photographing the Moon. For exposures over one second, use the "hat trick." This technique incorporates a hand-held black card placed over the aperture of the telescope to act as a shutter. The card prevents light from entering the telescope while the shutter is released. Once the shutter has been released and the vibration has diminished (a few seconds), move the black card out of the way to expose the film. After the exposure is complete, place the card over the front of the telescope and close the shutter. Advance the film and you're ready for your next shot. Keep in mind that the card should be held a few inches in front of the telescope, and not touching it. It is easier if you use two people for this process; one to release the camera shutter and one to hold the card. Here's the process for making the exposure.

1. Find and center the desired target in the viewfinder of your camera.
2. Turn the focus knob until the image is as sharp as possible.
3. Place the black card over the front of the telescope.
4. Release the shutter using a cable release.
5. Wait for the vibration caused by releasing the shutter to diminish. Also, wait for a moment of good seeing.
6. Remove the black card from in front of the telescope for the duration of the exposure (see accompanying table).
7. Replace the black card over the front of the telescope.
8. Close the camera's shutter.

Advance the film and you are ready for your next exposure. Don't forget to take photos of varying duration and keep accurate records of what you have done. Record the date, telescope, exposure duration, eyepiece, f/ratio, film and some comments on the seeing conditions.

The following table lists exposures for eyepiece projection with a 10 mm eyepiece. All exposure times are listed in seconds or fractions of a second.

Planet	ISO 50	ISO 100	ISO 200	ISO 400
Moon	4	2	1	1/2
Mercury	16	8	4	2
Venus	1/2	1/4	1/8	1/15
Mars	16	8	4	2
Jupiter	8	4	2	1
Saturn	16	8	4	2

FIGURE 8-4

RECOMMENDED EXPOSURE TIME FOR PHOTOGRAPHING PLANETS.

The exposure times listed here should be used as a starting point. Always make exposures that are longer and shorter than the recommended time. Also, take a few photos at each shutter speed. This will ensure that you get a good photo. It is not uncommon to go through an entire roll of 36 exposures and have only one good shot.

NOTE: Don't expect to record more detail than you can see visually in the eyepiece at the time you are photographing.

Once you have mastered the technique, experiment with different films, different focal length eyepieces and even different filters.

>> LONG EXPOSURE PRIME FOCUS PHOTOGRAPHY

This is the last form of celestial photography to be attempted after others have been mastered. It is intended primarily for deep sky objects that are objects outside our solar system which includes star clusters, nebulae and galaxies. While it may seem that high magnification is required for these objects, just the opposite is true. Most of these objects cover large angular areas and fit nicely into the prime focus field of your telescope. The brightness of these objects, however, requires long exposure times and, as a result, are rather difficult to photograph.

There are several techniques for this type of photography, and the one chosen will determine the standard accessories needed. The best method for long exposure deep sky astrophotography is with an off-axis guider. This device allows you to photograph and guide through the telescope simultaneously. Celestron offers a very special and advanced off-axis guider, called the Radial Guider (#94176). In addition, you will need a T-Ring to attach your camera to the Radial Guider.

Other equipment needs include a guiding eyepiece. Unlike other forms of astrophotography which allows for fairly loose guiding, prime focus requires meticulous guiding for long periods. To accomplish this you need a guiding ocular with an illuminated reticle to monitor your guide star. For this purpose, Celestron offers the Micro Guide Eyepiece (#94171). Here is a brief summary of the technique.

1. Polar align the telescope using an optional equatorial wedge. To polar align the CPC you must select EQ North Align (or EO South Align) from the alignment options. For more information on polar aligning, see the Polar Alignment section earlier in the manual.
2. Remove all visual accessories.
3. Thread the Radial Guider onto your telescope.
4. Thread the T-Ring onto the Radial Guider.

5. Mount your camera body onto the T-Ring the same as you would any other lens.
6. Set the shutter speed to the "B" setting.
7. Focus the telescope on a star.
8. Center your subject in the field of your camera.
9. Find a suitable guide star in the telescope field. This can be the most time consuming process.
10. Open the shutter using a cable release.
11. Monitor your guide star for the duration of the exposure using the buttons on the hand controller to make the needed corrections.
12. Close the camera's shutter.

>> PERIODIC ERROR CORRECTION (PEC)

PEC for short, is a system that improves the tracking accuracy of the drive by reducing the number of user corrections needed to keep a guide star centered in the eyepiece. PEC is designed to improve photographic quality by reducing the amplitude of the worm errors. Using the PEC function is a three-step process. First, the CPC needs to know the current position of its worm gear so that it has a reference when playing back the recorded error. Next, you must guide for at least 8 minutes during which time the system records the correction you make. (It takes the worm gear 8 minutes to make one complete revolution, hence the need to guide for 8 minutes). This "teaches" the PEC chip the characteristics of the worm. The periodic error of the worm gear drive will be stored in the PEC chip and used to correct periodic error. The last step is to play back the corrections you made during the recording phase. Keep in mind, this feature is for advanced astrophotography and still requires careful guiding since all telescope drives have some periodic error.

Using Periodic Error Correction

Once the telescope has been polar aligned using the EQ North Align (or EQ South for southern hemisphere) method, select PEC from the Utilities menu and press ENTER to begin recording your periodic error. Here's how to use the PEC function.

1. Find a bright star relatively close to the object you want to photograph.
2. Insert a high power eyepiece with illuminated cross hairs into your telescope. Orient the guiding eyepiece cross hairs so that one is parallel to the declination while the other is parallel to the R.A. axis.
3. Center the guide star on the illuminated cross hairs, focus the telescope and study the periodic movement.
4. Before actually recording the periodic error, take a few minutes to practice guiding. Set the hand control slew rate to an appropriate guide rate (rate 1 = .5x, rate 2 = 1x) and practice centering the guide star in the cross hairs for several minutes. This will help you familiarize yourself with the periodic error of the drive and the operation of the hand control. Remember to ignore declination drift when programming the PEC.

Note: *When recording PEC, only the photo guide rates (rates 1 and 2) will be operational. This eliminates the possibility of moving the telescope suddenly while recording.*

5. To begin recording the drive's periodic error, press the MENU button and select PEC from the Utilities menu. Use the UP/DOWN scroll buttons to display the Record option and press ENTER. You will have 5 seconds before the system starts to record. The first time each observing session that PEC record or play is selected, the worm gear must rotate in order to mark its starting position. If the rotation of

the worm gear moves your guide star outside the field of view of the eyepiece, it will have to be re-centered before the recording begins.

Once the worm gear is indexed, it will not need to be positioned again until the telescope is turned-off. So, to give yourself more time to prepare for guiding, it is best to restart PEC recording after the worm gear has found its index.

6. After 8 minutes, PEC will automatically stop recording.
7. Point the telescope at the object you want to photograph and center the guide star on the illuminated cross hairs and you are ready to play back the periodic error correction.
8. Once the drive's periodic error has been recorded, use the Playback function to begin playing back the correction for future photographic guiding. If you want to re-record the periodic error, select Record and repeat the recording processes again. The previously recorded information will be replaced with the current information. Repeat steps 7 and 8 to playback the PEC corrections for your next object.

Does the PEC function make unguided astrophotography possible? Yes and no. For solar (filtered), lunar and piggyback (up to 200 mm), the answer is yes. However, even with PEC, off-axis guiding is still mandatory for long exposure, deep sky astrophotography. The optional Reducer/Corrector lens reduces exposure times making the task of guiding a little easier.

When getting started, use fast films to record as much detail in the shortest possible time. Here are proven recommendations:

- Ektar 1000 (color print)
- Konica 3200 (color print)
- Fujichrome 1600D (color slide)
- 3M 1000 (color slide)
- Scotchchrome 400
- T-Max 3200 (black and white print)
- T-Max 400 (black and white print)

As you perfect your technique, try specialized films, which are films that are designed or specially treated for celestial photography. Here are some popular choices:

- Ektar 125 (color print)
- Fujichrome 100D (color slide)
- Tech Pan, gas hypered (black and white print)
- T-Max 400 (black and white print)

There is no exposure determination table to help you get started. The best ways to determine exposure length is to look at previously published photos to see what film/exposure combinations were used or take unguided sample photos of various parts of the sky while the drive is running. Always take exposures of various lengths to determine the best exposure time.

>> TERRESTRIAL PHOTOGRAPHY

Your CPC makes an excellent telephoto lens for terrestrial (land) photography. Terrestrial photography is best done with the telescope in Alt-Az configuration and the tracking drive turned off. To turn the tracking drive off, press the MENU (9) button on the hand control and scroll down to the Tracking Mode sub menu. Use the UP and DOWN scroll keys (10) to select the Off option and press ENTER. This will turn the tracking motors off so that objects will remain in your camera's field of view.

Metering

The CPC has a fixed aperture, and as a result, fixed f/ratios. To properly expose your subjects photographically, you need to set your shutter speed accordingly. Most 35 mm SLR cameras offer through-the-lens

metering which lets you know if your picture is under or overexposed. Adjustments for proper exposures are made by changing the shutter speed. Consult your camera's manual for specific information on metering and changing shutter speeds

Reducing Vibration

Releasing the shutter manually can cause vibrations, producing blurred photos. To reduce vibration when tripping the shutter, use a cable release. A cable release keeps your hands clear of the camera and lens, thus eliminating the possibility of introducing vibration. Mechanical shutter releases can be used, though air-type releases are best. Blurry pictures can also result from shutter speeds that are too slow. To prevent this, use films that produce shutter speeds greater than 1/250 of a second when hand-holding the lens. If the lens is mounted on a tripod, the exposure length is virtually unlimited.

Another way to reduce vibration is with the Vibration Suppression Pads (#93503). These pads rest between the ground and tripod feet. They reduce the vibration amplitude and vibration time.

The following is a brief description of the advantages of imaging at each f-number configuration and the proper equipment needed to use the telescope in any of its many settings

f/6.3 with Reducer/Corrector

When imaging some objects like planetary nebula (for example M57, the Ring Nebula) and small galaxies (M104, the Sombrero Galaxy), larger image scale is needed to resolve finer detail. These objects are better shot at f/6.3 or even f/10.

Medium size to small galaxies – f/6.3 imaging gives you finer resolution than at f/2, but the slower f-number will usually require you to guide the image while you are taking longer exposures. Guiding can be accomplished by using an optional Radial Guider or a piggyback guide scope. The exposure times are about 10 times longer, but the results can be worth the extra effort. There are some objects that are small enough and bright enough that they work great at f/6.3. M104 (the Sombrero Galaxy) can be imaged under dark skies with a series of short exposures using Track and Accumulate. Ten exposures at 15 seconds each will yield a nice image and is short enough that you may not need to guide the exposure at all. For f/6.3 imaging, the optional Reducer/Corrector is needed. (See Optional Accessory section at the end of this manual).

Lunar or small planetary nebulae – f/10 imaging is more challenging for long exposure, deep-sky imaging. Guiding needs to be very accurate and the exposure times need to be much longer, about 25 times longer than f/2. There are only a select few objects that work well at f/10. The Moon images fine because it is so bright, but planets are still a bit small and should be shot at f/20. The Ring Nebula is a good candidate because it is small and bright. The Ring Nebula (M57) can be imaged in about 30-50 seconds at f/10. The longer the exposure, the better.

Planetary or Lunar – f/20 is a great way to image the planets and features on the Moon. When imaging the planets, very short exposures are needed. The exposure lengths range from .03 to .1 seconds on planetary images. Focus is critical as is good atmospheric conditions. Generally you will take one image after another until one looks good. This is due to the atmospheric "seeing" conditions. For every 10 exposures you might save 1. To image at f/20, you need to purchase a 2x Barlow and a T-adaptor or Radial Guider.

>> CCD IMAGING

Fastar Option – Using your EdgeHD telescope at f/2 with optional lens assembly.

The EdgeHD telescopes are equipped with a removable secondary mirror that allows you to convert your f/10 telescope into an f/2 imaging system capable of exposure times 25 times shorter than those needed with a f/10 system! The Fastar compatible telescope's versatility allows it to be used in many different f-number configurations for CCD imaging, making it the most versatile imaging system available today. With an optional lens assembly you can easily convert your Fastar compatible telescope to f/2 prime focus use in a matter of seconds. This makes the system ideal for imaging deep-sky objects as well as planetary detail. Described below is the configuration of each f-number and the type of object best suited to that kind of imaging.

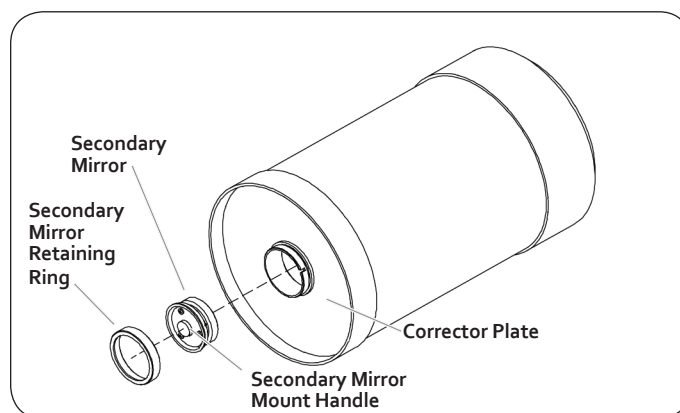

FIGURE 8-5

THE FASTAR COMPATIBLE OPTICAL SYSTEM

The above figure shows how the secondary mirror is removed when using the optional CCD camera for f/2 imaging.

Warning: The secondary mirror should never be removed unless installing the optional f/2 lens assembly. Adjustments to collimation can easily be made by turning the screws on the top of the secondary mirror mount without ever having to remove the secondary mirror (see Telescope Maintenance section of this manual).

The f/# stands for the ratio between the focal length and the diameter of the light gathering element. For example, the EdgeHD 11" optical tube has a focal length of 110 inches and a diameter of 11 inches. This makes the system an f/10, (focal length divided by diameter). When the secondary is removed and the CCD camera is placed at the Fastar position, the system becomes f/2. This is a unique feature to some Celestron telescopes (see figures below).

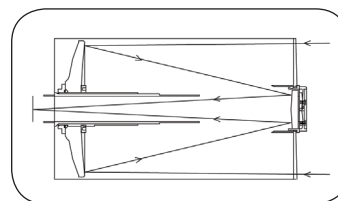

FIGURE 8-6

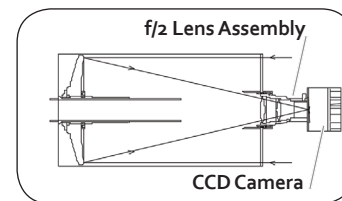

FIGURE 8-7

The key factors for good CCD imaging are; exposure time, field-of-view, image size and pixel resolution. As the f-number goes down (or gets faster), the exposure times needed decreases, the field-of-view-increases, but the image scale of the object gets smaller. What is the difference between f/2 and f/10? F/2 has 1/5 the focal length of f/10.

That makes the exposure time needed about 25 times shorter than at f/10, the field of view 5 times larger and the object size 1/5 compared to that of f/10 (see Figure 8-8).

TELESCOPE MODEL	STANDARD F/10 CONFIGURATION	F/2 CONFIGURATION
8"	80" (2032 mm)	16" (406.4 mm)
9.25"	93" (2350 mm)	18.5" (470 mm)
11"	110" (2800 mm)	23.1" (587 mm)

FIGURE 8-8

Auto Guiding

The CPC has a designated auto guiding port for use with a CCD autoguider. Figure 8-9 may be useful when connecting the CCD camera cable to the CPC and calibrating the autoguider. Note that the four outputs are active-low with internal pull-ups and are capable of sinking 25 mA DC.

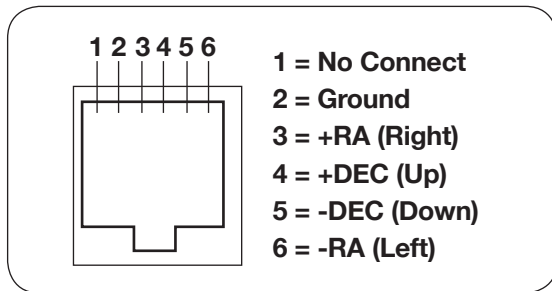

FIGURE 8-9

PIN OUT DIAGRAM FOR AUTOGUIDER

TELESCOPE MAINTENANCE

While your CPC telescope requires little maintenance, there are a few things to remember that will ensure your telescope performs at its best.

>> CARE AND CLEANING OF THE OPTICS

Occasionally, dust and/or moisture may build up on the corrector plate of your telescope. Special care should be taken when cleaning any instrument so as not to damage the optics.

If dust has built up on the corrector plate, remove it with a brush (made of camel's hair) or a can of pressurized air. Spray at an angle to the lens for approximately two to four seconds. Then, use an optical cleaning solution and white tissue paper to remove any remaining debris. Apply the solution to the tissue and then apply the tissue paper to the lens. Low pressure strokes should go from the center of the corrector to the outer portion. Do NOT rub in circles!

You can use a commercially made lens cleaner or mix your own. A good cleaning solution is isopropyl alcohol mixed with distilled water. The solution should be 60% isopropyl alcohol and 40% distilled water. Or, liquid dish soap diluted with water (a couple of drops per one quart of water) can be used.

>> COLLIMATION

The optical performance of your CPC telescope is directly related to its collimation, that is the alignment of its optical system. Your CPC was collimated at the factory after it was completely assembled. However, if the telescope is dropped or jarred severely during transport, it may have to be collimated. The only optical element that may need to be adjusted, or is possible, is the tilt of the secondary mirror.

To check the collimation of your telescope you will need a light source. A bright star near the zenith is ideal since there is a minimal amount of atmospheric distortion. Make sure that tracking is on so that you won't have to manually track the star. Or, if you do not want to power up your telescope, you can use Polaris. Its position relative to the celestial pole means that it moves very little thus eliminating the need to manually track it.

Before you begin the collimation process, be sure that your telescope is in thermal equilibrium with the surroundings. Allow 45 minutes for the telescope to reach equilibrium if you move it between large temperature extremes.

Occasionally, you may experience dew build-up on the corrector plate of your telescope during an observing session. If you want to continue observing, the dew must be removed, either with a hair dryer (on low setting) or by pointing the telescope at the ground until the dew has evaporated.

If moisture condenses on the inside of the corrector, remove the accessories from the rear cell of the telescope. Place the telescope in a dust-free environment and point it down. This will remove the moisture from the telescope tube.

To minimize the need to clean your telescope, replace all lens covers once you have finished using it. Since the rear cell is NOT sealed, the cover should be placed over the opening when not in use. This will prevent contaminants from entering the optical tube.

Internal adjustments and cleaning should be done only by the Celestron repair department. If your telescope is in need of internal cleaning, please call the factory for a return authorization number and price quote.

To verify collimation, view a star near the zenith. Use a medium to high power ocular – 1 mm to 6 mm focal length. It is important to center a star in the center of the field to judge collimation. Slowly cross in and out of focus and judge the symmetry of the star. If you see a systematic skewing of the star to one side, then re-collimation is needed.



FIGURE 9-1

COLLIMATION ADJUSTMENT SCREWS

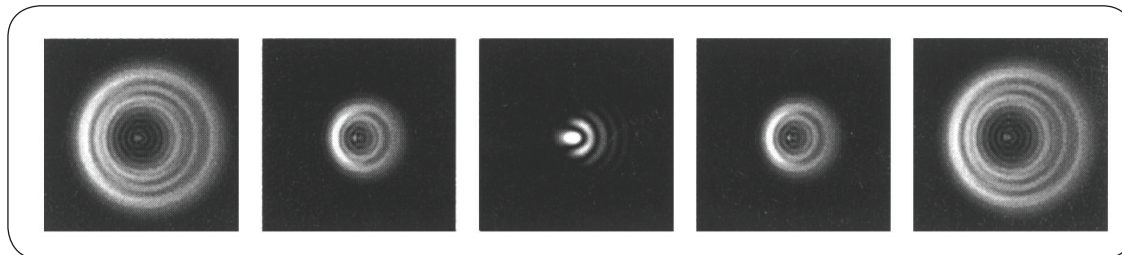

FIGURE 9-2

EVEN THOUGH THE STAR PATTERN APPEARS THE SAME ON BOTH SIDES OF FOCUS, THEY ARE ASYMMETRIC. THE DARK OBSTRUCTION IS SKEWED OFF TO THE LEFT SIDE OF THE DIFFRACTION PATTERN INDICATING POOR COLLIMATION.

To accomplish this, you need to tighten the secondary collimation screw(s) that move the star across the field toward the direction of the skewed light. These screws are located on the secondary mirror holder (see figure 9-1). To access the collimation screws you will need to remove the collimation screw cover to expose the three collimation screws underneath. To remove the cover, place the tip of a flat screwdriver underneath the cover and twist until the cover lifts off. Make only small 1/6 to 1/8 adjustments to the collimation screws and re-center the star by moving the scope before making any improvements or before making further adjustments.

To make collimation a simple procedure, follow these easy steps:

1. While looking through a medium to high power eyepiece, de-focus a bright star until a ring pattern with a dark shadow appears (see figure 9-2). Center the de-focused star and notice in which direction the central shadow is skewed.
2. Place your finger along the edge of the front cell of the telescope (be careful not to touch the corrector plate), pointing towards the collimation screws. The shadow of your finger should be visible when looking into the eyepiece. Rotate your finger around the tube edge until its shadow is seen closest to the narrowest portion of the rings (i.e., the same direction in which the central shadow is skewed).
3. Locate the collimation screw closest to where your finger is positioned. This will be the collimation screw you will need to adjust first. (If your finger is positioned exactly between two of the collimation screws, then you will need to adjust the screw opposite where your finger is located).
4. Use the hand control buttons to move the de-focused star image to the edge of the field of view in the same direction that the central obstruction of the star image is skewed.
5. While looking through the eyepiece, use an Allen wrench to turn the collimation screw you located in step 2 and 3. Usually a tenth of a turn is enough to notice a change in collimation. If the star image moves

out of the field of view in the direction that the central shadow is skewed, than you are turning the collimation screw the wrong way. Turn the screw in the opposite direction, so that the star image is moving towards the center of the field of view.

6. If while turning you notice that the screws get very loose, then simply tighten the other two screws by the same amount. Conversely, if the collimation screw gets too tight, then loosen the other two screws by the same amount.
7. Once the star image is in the center of the field of view, check to see if the rings are concentric. If the central obstruction is still skewed in the same direction, then continue turning the screw(s) in the same direction. If you find that the ring pattern is skewed in a different direction, than simply repeat steps 2 through 6 as described above for the new direction.

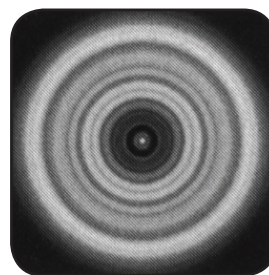

FIGURE 9-3

A COLLIMATED TELESCOPE SHOULD APPEAR SYMMETRICAL WITH THE CENTRAL OBSTRUCTION CENTERED IN THE STAR'S DIFFRACTION PATTERN.

Perfect collimation will yield a star image very symmetrical just inside and outside of focus. In addition, perfect collimation delivers the optimal optical performance specifications that your telescope is built to achieve. If seeing (i.e., air steadiness) is turbulent, collimation is difficult to judge. Wait until a better night if it is turbulent or aim to a steadier part of the sky. A steadier part of the sky is judged by steady versus twinkling stars.

OPTIONAL ACCESSORIES

You will find that additional accessories enhance your viewing pleasure and expand the usefulness of your telescope. For ease of reference, all the accessories are listed in alphabetical order.

Erect Image Diagonal (#94112-A) – This accessory is an Amici prism arrangement that allows you to look into the telescope at a 45° angle with images that are oriented properly (upright and correct from left-to-right). It is useful for daytime, terrestrial viewing.

Eyepieces – Like telescopes, eyepieces come in a variety of designs. Each design has its own advantages and disadvantages. For the 1.25" barrel diameter there are four different eyepiece designs available.

OMNI Plössl – Plössl eyepieces have a 4-element lens designed for low-to-high power observing. All are fully multi-coated for maximum light transmission. These Plössls offer razor sharp views across the entire field, even at the edges! In the 1.25" barrel diameter, they are available in the following focal lengths: 3.6 mm, 6 mm, 8 mm, 10 mm, 13 mm, 17 mm, 25 mm, 32 mm and 40 mm.

X-CEL LX – The newly enhanced X-Cel LX eyepiece series is what you've been waiting for in a high quality eyepiece for planetary viewing. With a brand new sleek and robust design and a twist-up eye guard, these eyepieces are especially designed for comfort and ease of use. They also

have a wide field of view of 60° and 6-element fully multi-coated optics for magnificent wide field performance. X-Cel LX eyepieces are parfocal and require little to no focusing when changing from low to high power. The X-Cel LX series is offered in the following seven sizes: 2.3 mm, 5 mm, 7 mm, 9 mm, 12 mm, 18 mm and 25 mm. **Ultima LX** – Celestron Ultima LX Series parfocal eyepieces feature wide fields of view for high and low magnifications. 70° field of view for high and low magnifications and extendable twist-up eyecups - Good for eyeglass wearers. Available in the following focal lengths: 5 mm, 8 mm, 13 mm, 17 mm, 22 mm and 32 mm.



Eyepiece, Micro Guide (#94171) – This multipurpose 12.5 mm illuminated reticle can be used for guiding deep-sky astrophotos, measuring position angles, angular separations and more. The laser etched reticle provides razor sharp lines, and the variable brightness illuminator is completely cordless. The Micro Guide Eyepiece produces 224 power when used with the CPC 1100 at f/10 and 163 power with the CPC 800.

Filters, Eyepiece (94119-10) –

Eyepiece filters are an invaluable aid in lunar and planetary observing. They reduce glare and light scattering, increase contrast through selective filtration, increase definition and resolution, reduce irradiation and lessen eye fatigue. Celestron's filters are made of high quality, solid plane parallel glass with excellent homogeneity. They're anti-reflection coated to prevent glaring and ghosting. All eyepiece filters are threaded to fit Celestron's, and most other manufacturer's, 1.25" eyepieces, and offer a full 26 mm clear aperture. Kit includes: 21, 80A, #15, ND-25 Neutral Density.



Flashlight, Night Vision (#93588) – Celestron's premium model for astronomy, using two red LEDs to preserve night vision better than red filters or other devices. Brightness is adjustable. Operates on a single 9 volt battery (included).

Light Pollution Reduction (LPR) Filters – These filters are designed to enhance your views of deep sky astronomical objects when viewed from urban areas. LPR Filters selectively reduce the transmission of certain wavelengths of light, specifically those produced by artificial lights. This includes mercury and high and low pressure sodium vapor lights. In addition, they also block unwanted natural light (sky glow) caused by neutral oxygen emission in our atmosphere. Celestron offers a model for 1.25" eyepieces (#94123) and 2" eyepieces (#94124).

PowerTank (#18774) – 12v 7Amp hour rechargeable power supply. Comes with two 12v output cigarette outlets, built-in red flash light, LED emergency spotlight. 120v AC adapter and cigarette lighter adapter included. Celestron also offers a 17 amp hour models (#18777).



Radial Guider (#94176) – The Celestron Radial Guider® is specifically designed for use in prime focus, deep sky astrophotography and takes the place of the T-Adapter. This device allows you to photograph and guide simultaneously through the optical tube assembly of your telescope. This type of guiding produces the best results since what you see through the guiding eyepiece is exactly reproduced on the processed film. The Radial



Guider is a "T"-shaped assembly that attaches to the rear cell of the telescope. As light from the telescope enters the guider, most passes straight through to the camera. A small portion, however, is diverted by a prism at an adjustable angle up to the guiding eyepiece. This guider has two features not found on other off-axis guiders; first, the prism and eyepiece housing rotate independently of the camera orientation making the acquisition of a guide star quite easy. Second, the

prism angle is tunable allowing you to look at guide stars on-axis. This accessory works especially well with the Reducer/Corrector.

T-Adapter – This T-Adapter allows you to attach your 35 mm DSLR camera to the prime focus of your EdgeHD telescope. This arrangement is used for terrestrial photography and short exposure lunar and planetary photography. It can also be used for long exposure deep-sky photography when using a separate guidescope. Model #93644 for CPC Deluxe 800 HD and Model #93646 for CPC Deluxe 925 and 1100 HD.



T-Ring – The T-Ring couples your 35 mm SLR camera body to the T-Adapter, radial guider, or tele-extender. This accessory is mandatory if you want to do DSLR photography through the telescope. Celestron provides a T-ring for both Nikon (#93402) and Canon (#93419).

Tele-Extender, Deluxe (#93643) – The tele-extender is a hollow tube that allows you to attach a camera to the telescope when the eyepiece is installed. This accessory is used for eyepiece projection photography which allows you to capture very high power views of the Sun, Moon and planets on film. The tele-extender fits over the eyepiece onto the visual back. This tele-extender works with eyepieces that have large housings, like the Celestron Ultima series.

HD Pro Wedge (#93664) – Celestron's HD Pro Wedge allows you to tilt the telescope so that its polar axis is parallel to the earth's axis of rotation. Ideal for using your CPC DeluxeHD for guided astrophotography. The Pro Wedge is designed to support our fork mounted telescopes up to 11". The HD Pro Wedge provides a heavy duty, stable platform that is perfect for astroimaging and guarantees minimal vibration. A low latitude range of 0-90 degrees makes this wedge functional for use at the equator.



A full description of all Celestron accessories can be found in the Celestron Accessory Catalog (#93685).

APPENDIX A – TECHNICAL SPECIFICATIONS

Optical Specification	CPC Deluxe 800 HD – #11007	CPC Deluxe 925 HD – #11008	CPC Deluxe 1100 HD – #11009
Design	203 mm (8") EdgeHD Optics	235 mm (9.25") EdgeHD Optics	280 mm (11") EdgeHD Optics
Focal Length	2032 mm	2350 mm	2800 mm
F/ratio of the Optical System	10	10	10
Primary Mirror: Material Coatings	Fine Annealed Pyrex Starbright XLT Coating	Fine Annealed Pyrex Starbright XLT Coating	Fine Annealed Pyrex Starbright XLT Coating
Central Obstruction	2.75"	3.35"	3.75"
Corrector Plate: Material Coatings	Optical Quality Crown Glass A-R Coatings both sides	Optical Quality Crown Glass A-R Coatings both sides	Optical Quality Crown Glass A-R Coatings both sides
Highest Useful Magnification	480x (~4 mm eyepiece)	555x (~4 mm eyepiece)	660x (~4 mm eyepiece)
Lowest Useful Magnification (7 mm exit pupil)	29x (~70 mm eyepiece)	34x (~70 mm eyepiece)	40x (~70 mm eyepiece)
Magnification: Standard Eyepiece	51x	102x	122x
Resolution: Rayleigh Criterion Dawes Limit	.68 arc seconds .57 arc seconds	.59 arc seconds .49 arc seconds	.50 arc seconds .42 arc seconds
Light Gathering Power	843x	1127x	1593x
Near Focus with Standard Eyepiece or Camera	~25 feet	~40 feet	~100 feet
Field of View: Standard Eyepiece	.85°	.8°	.67°
Linear Field of View (at 1000 yds)	44 ft.	42 ft.	35 ft.
Optical Tube Length	17"	22"	24"
Weight of Telescope	42 lbs	58 lbs	65 lbs
Weight of Tripod	19 lbs	19 lbs	19 lbs

ELECTRONIC SPECIFICATIONS

Input Voltage	12 V DC Nominal
Maximum	15 V DC Max
Minimum	9 V DC Min
Power Supply Requirements	12 VDC-2.5A (Tip positive)
GPS	Internal 48 channel

MECHANICAL SPECIFICATIONS

Motor: Type	DC Servo motors with encoders, both axes
Resolution	.1406 arc sec
Slew speeds	Nine slew speeds: 4°/sec, 2°/sec, .5°/sec, 64x, 16x, 8x, 4x, 1x, .5x
Hand Control	Double line, 16 character Liquid Crystal Display 19 fiber optic backlit LED keypad
Fork Arm	Dual Fork tine cast aluminum with detachable HC holder
Gears	5.78", precision brass gears on RA axes, 180 tooth. Stainless steel worm gear
Bearings	9.8" Azimuth Bearing Surface
Optical Tube	Aluminum

SOFTWARE SPECIFICATIONS

Ports	RS-232 communication port on hand control, Autoguider Port, 2 Auxiliary Port, PC Port
Period Error Correction	Permanently programmable
Tracking Rates	Sidereal, Solar, Lunar
Tracking Modes	Alt-Az, EQ North and EQ South
Alignment Procedures	Sky Align, Auto Two-Star Align, Two-Star Align, Solar System Align, EQ North Align and EQ South Align
Database	40,000+ objects, 99 user defined programmable objects. Enhanced information on over 200 objects
Complete Revised NGC Catalog	7,840
Complete Messier Catalog	110
Complete IC Catalog	5,386
Complete Caldwell	109
Abell Galaxies	2,712
Solar System objects	9
Famous Asterisms	20
Selected CCD Imaging Objects	25
Selected SAO Stars	29,500

APPENDIX B - GLOSSARY OF TERMS

A –

Absolute magnitude

The apparent magnitude that a star would have if it were observed from a standard distance of 10 parsecs, or 32.6 light-years. The absolute magnitude of the Sun is 4.8. at a distance of 10 parsecs, it would just be visible on Earth on a clear moonless night away from surface light.

Airy disk

The apparent size of a star's disk produced even by a perfect optical system. Since the star can never be focused perfectly, 84 per cent of the light will concentrate into a single disk, and 16 per cent into a system of surrounding rings.

Alt–Azimuth Mounting

A telescope mounting using two independent rotation axes allowing movement of the instrument in Altitude and Azimuth.

Altitude

In astronomy, the altitude of a celestial object is its Angular Distance above or below the celestial horizon.

Aperture

The diameter of a telescope's primary lens or mirror; the larger the aperture, the greater the telescope's light-gathering power.

Apparent Magnitude

A measure of the relative brightness of a star or other celestial object as perceived by an observer on Earth.

Arc minute

A unit of angular size equal to 1/60 of a degree.

Arc second

A unit of angular size equal to 1/3,600 of a degree (or 1/60 of an arc minute).

Asterism

A small unofficial grouping of stars in the night sky.

Asteroid

A small, rocky body that orbits a star.

Astrology

The pseudoscientific belief that the positions of stars

and planets exert an influence on human affairs; astrology has nothing in common with astronomy.

Astronomical unit (AU)

The distance between the Earth and the Sun. It is equal to 149,597,900 km., usually rounded off to 150,000,000 km.

Aurora

The emission of light when charged particles from the solar wind slams into and excites atoms and molecules in a planet's upper atmosphere.

Azimuth

The angular distance of an object eastwards along the horizon, measured from due north, between the astronomical meridian (the vertical line passing through the center of the sky and the north and south points on the horizon) and the vertical line containing the celestial body whose position is to be measured.

B –

Binary Stars

Binary (Double) stars are pairs of stars that, because of their mutual gravitational attraction, orbit around a common center of mass. If a group of three or more stars revolve around one another, it is called a multiple system. It is believed that approximately 50 percent of all stars belong to binary or multiple systems. Systems with individual components that can be seen separately by a telescope are called visual binaries or visual multiples. The nearest "star" to our solar system, Alpha Centauri, is actually our nearest example of a multiple star system. It consists of three stars, two very similar to our Sun and one dim, small, red star orbiting around one another.

C –

Celestial Equator

The projection of the Earth's equator on to the celestial sphere. It divides the sky into two equal hemispheres.

<i>Celestial pole</i>	The imaginary projection of Earth's rotational axis north or south pole onto the celestial sphere.	<i>Meridian</i>	A reference line in the sky that starts at the North celestial pole and ends at the South celestial pole and passes through the zenith. If you are facing South, the meridian starts from your Southern horizon and passes directly overhead to the North celestial pole.
<i>Celestial Sphere</i>	An imaginary sphere surrounding the Earth, concentric with the Earth's center.	<i>Messier</i>	A French astronomer in the late 1700s who was primarily looking for comets. Comets are hazy diffuse objects and so Messier cataloged objects that were not comets to help his search. This catalog became the Messier Catalog, M ₁ through M ₁₁₀ .
<i>Collimation</i>	The act of putting a telescope's optics into perfect alignment.	D –	
D –		<i>Declination (DEC)</i>	The angular distance of a celestial body north or south of the celestial equator. It may be said to correspond to latitude on the surface of the Earth.
E –		<i>Ecliptic</i>	The projection of the Earth's orbit on to the celestial sphere. It may also be defined as "the apparent yearly path of the Sun against the stars."
<i>Equatorial mount</i>	A telescope mounting in which the instrument is set upon an axis which is parallel to the axis of the Earth; the angle of the axis must be equal to the observer's latitude.	N –	
F –		<i>Nebula</i>	Interstellar cloud of gas and dust. Also refers to any celestial object that has a cloudy appearance.
<i>Focal length</i>	The distance between a lens (or mirror) and the point at which the image of an object at infinity is brought to focus. The focal length divided by the aperture of the mirror or lens is termed the focal ratio.	<i>North Celestial Pole</i>	The point in the Northern hemisphere around which all the stars appear to rotate. This is caused by the fact that the Earth is rotating on an axis that passes through the North and South celestial poles. The star Polaris lies less than a degree from this point and is therefore referred to as the "Pole Star".
G –		<i>Nova</i>	Although Latin for "new" it denotes a star that suddenly becomes explosively bright at the end of its life cycle.
<i>GoTo</i>	Term used to refer to a computerized telescope or to the act of slewing (moving) a computerized telescope.	O –	
J –		<i>Open Cluster</i>	One of the groupings of stars that are concentrated along the plane of the Milky Way. Most have an asymmetrical appearance and are loosely assembled. They contain from a dozen to many hundreds of stars.
<i>Jovian Planets</i>	Any of the four gas giant planets that are at a greater distance from the Sun than the terrestrial planets.	P –	
K –		<i>Parallax</i>	Parallax is the difference in the apparent position of an object against a background when viewed by an observer from two different locations. These positions and the actual position of the object form a triangle from which the apex angle (the parallax) and the distance of the object can be determined if the length of the baseline between the observing positions is known and the angular direction of the object from each position at the ends of the baseline has been measured. The traditional method in astronomy of determining the distance to a celestial object is to measure its parallax.
<i>Kuiper Belt</i>	A region beyond the orbit of Neptune extending to about 1000 AU which is a source of many short period comets.	<i>Parfocal</i>	Refers to a group of eyepieces that all require the same distance from the focal plane of the telescope to be in focus. This means when you focus one parfocal eyepiece all the other parfocal eyepieces, in a particular line of eyepieces, will be in focus.
L –		<i>Parsec</i>	The distance at which a star would show parallax of one second of arc. It is equal to 3.26 light-years, 206,265 astronomical units, or 30,800,000,000,000 km. (Apart from the Sun, no star lies within one parsec of us.)
<i>Light-Year (ly)</i>	A light-year is the distance light traverses in a vacuum in one year at the speed of 186,000 mi/sec. (299,792 km/sec.) With 31,557,600 seconds in a year, the light-year equals a distance of 5.88 trillion miles (9.46 trillion km).	<i>Point Source</i>	An object which cannot be resolved into an image because it is too far away or too small is considered a point source. A planet is far away but it can be resolved as a disk. Most stars cannot be resolved as disks, they are too far away.
M –			
<i>Magnitude</i>	Magnitude is a measure of the brightness of a celestial body. The brightest stars are assigned magnitude 1 and those increasingly fainter from 2 down to magnitude 5. The faintest star that can be seen without a telescope is about magnitude 6. Each magnitude step corresponds to a ratio of 2.5 in brightness. Thus a star of magnitude 1 is 2.5 times brighter than a star of magnitude 2, and 100 times brighter than a magnitude 5 star. The brightest star, Sirius, has an apparent magnitude of -1.6, the full moon is -12.7, and the Sun's brightness, expressed on a magnitude scale, is -26.78. The zero point of the apparent magnitude scale is arbitrary.		

R –

Reflector A telescope in which the light is collected by means of a mirror.

Resolution The minimum detectable angle an optical system can detect. Because of diffraction, there is a limit to the minimum angle, resolution. The larger the aperture, the better the resolution.

Right Ascension: (RA) The angular distance of a celestial object measured in hours, minutes and seconds along the Celestial Equator eastward from the Vernal Equinox.

S –

Schmidt Telescope *Rated the most important advance in optics. In 200 years, the Schmidt telescope combines the best features of the refractor and reflector for photographic purposes. It was invented in 1930 by Bernhard Voldemar Schmidt (1879-1935).*

Sidereal Rate This is the angular speed at which the Earth is rotating. Telescope tracking motors drive the telescope at this rate. The rate is 15 arc seconds per second or 15 degrees per hour.

T –

Terminator The boundary line between the light and dark portion of the Moon or a planet.

U –

Universe The totality of astronomical things, events, relations and energies capable of being described objectively.

V –

Variable Star A star whose brightness varies over time due to either inherent properties of the star or something eclipsing or obscuring the brightness of the star.

W –

Waning Moon The period of the Moon's cycle between full and new, when its illuminated portion is decreasing.

Waxing Moon The period of the Moon's cycle between new and full, when its illuminated portion is increasing.

Z –

Zenith The point on the Celestial Sphere directly above the observer.

Zodiac The zodiac is the portion of the Celestial Sphere that lies within 8 degrees on either side of the Ecliptic. The apparent paths of the Sun, the Moon, and the planets, with the exception of some portions of the path of Pluto, lie within this band. Twelve divisions, or signs, each 30 degrees in width, comprise the zodiac. These signs coincided with the zodiacal constellations about 2,000 years ago. Because of the Precession of the Earth's axis, the Vernal Equinox has moved westward by about 30 degrees since that time; the signs have moved with it and thus no longer coincide with the constellations.

APPENDIX C - RS-232 CONNECTION (FOR COMPUTERIZED HAND CONTROL)

You can control your NexStar telescope with a computer via the RS-232 port on the computerized hand control and using an optional RS-232 cable (#93920). Once connected, the NexStar can be controlled using popular astronomy software programs.

Communication Protocol

CPC communicates at 9600 bits/sec. No parity and a stop bit. All angles are communicated with 16 bit angle and communicated using ASCII hexadecimal.

Description	PC Command ASCII	Hand Control Response	Notes
Echo	Kx	X#	Useful to check communication
GoTo Azm-Alt	B12AB, 4000		10 characters sent. B=Command, 12AB=Azm, comma, 4000=Alt. If command conflicts with slew limits, there will be no action.
GoTo Ra-Dec	R34AB, 12CE		Scope must be aligned. If command conflicts with slew limits, there will be no action.
Get Azm-Alt	Z	12AB, 4000#	10 characters returned, 12AB=Azm, comma, 4000=Alt, #
Get RA-Dec	E	34AB, 12CE#	Scope must be aligned
Cancel GoTo	M		
Is GoTo in Progress	L	# or 1#	0=No, 1=Yes

Commands below available on version 1.6 or later

HC version	V	1 6 #	Version 1.6
Stop/Start Tracking	Tx x = 0 (Tracking off) x = 1 (Alt-Az on) x = 2 (EQ-N) x = 3 (EQ-S)		Alt-Az tracking requires alignment
32-bit GoTo RA-Dec	r34AB0500,12CE0500		
32-bit get RA-Dec	e	34AB0500,12CE0500#	The last two characters will always be zero.
32-bit GoTo Azm-Alt	b34AB0500,12CE0500		
32-bit get Azm-Alt	z	34AB0500,12CE0500#	The last two characters will always be zero.



THE CABLE REQUIRED TO INTERFACE TO THE TELESCOPE HAS AN RS-232 MALE PLUG AT ONE END AND A 4-4 TELEPHONE JACK AT THE OTHER END. THE WIRING IS AS FOLLOWS:

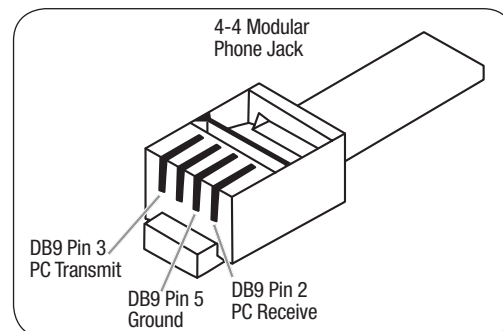

APPENDIX D – MAPS OF TIME ZONES

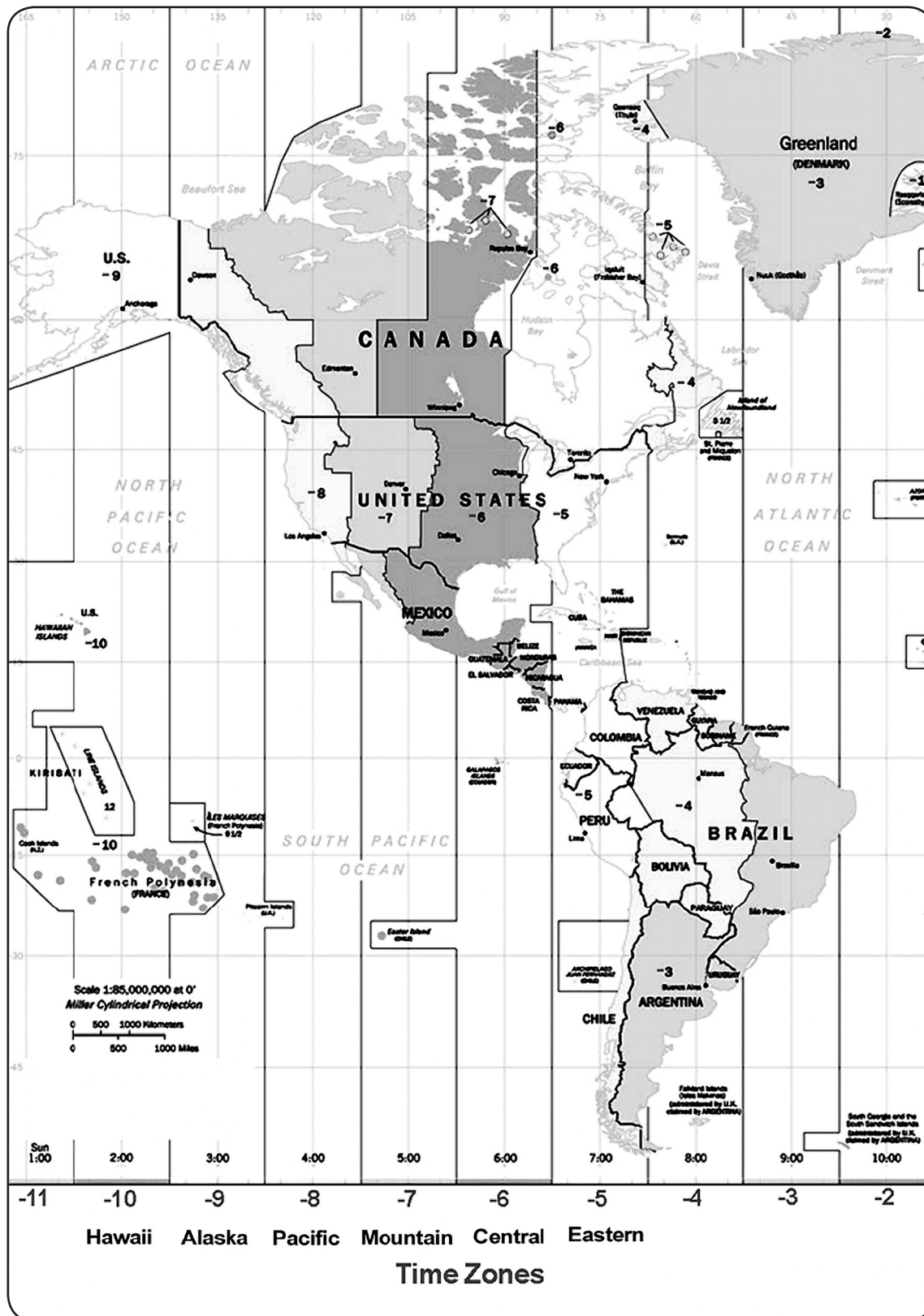

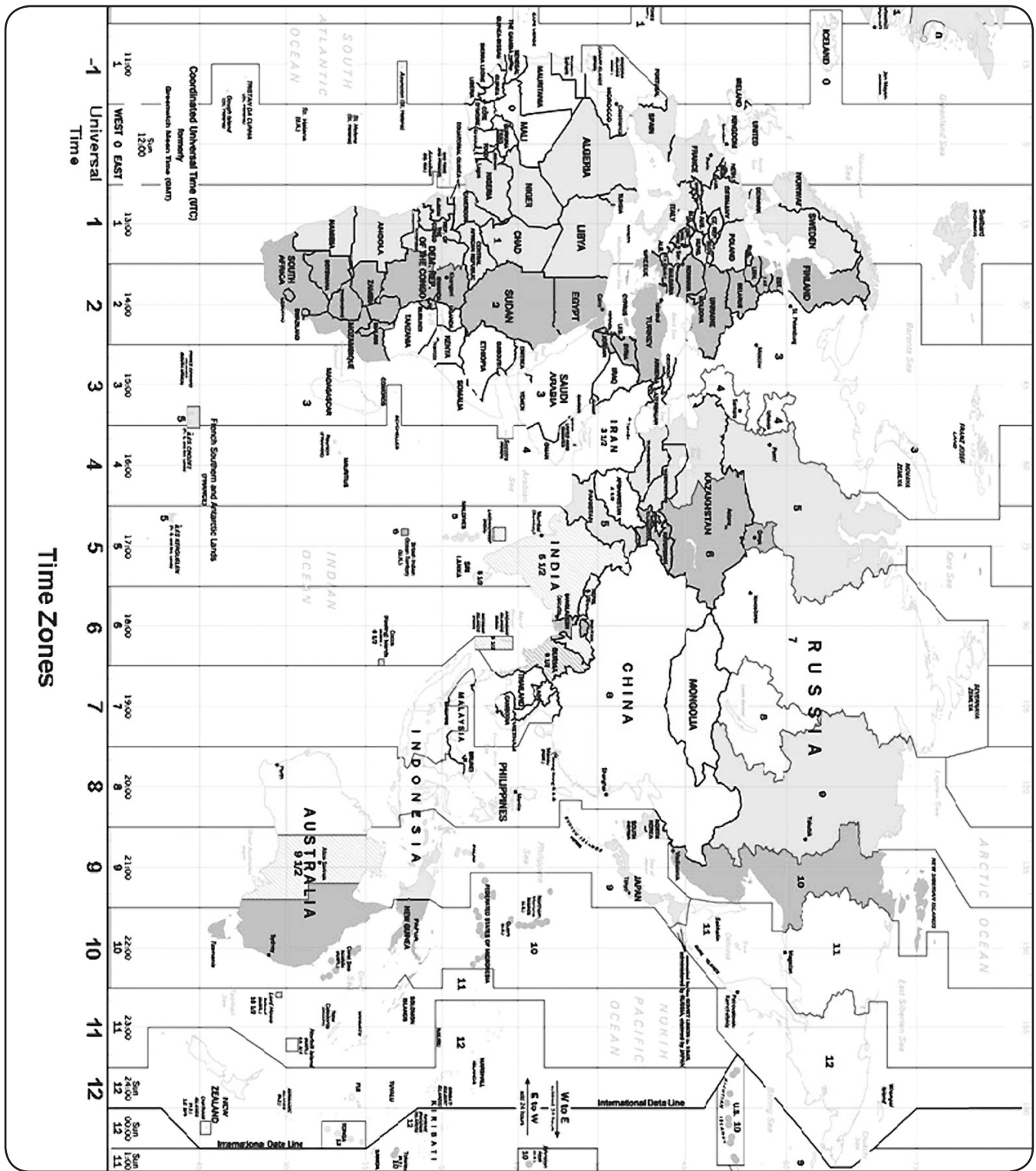

January - February Sky

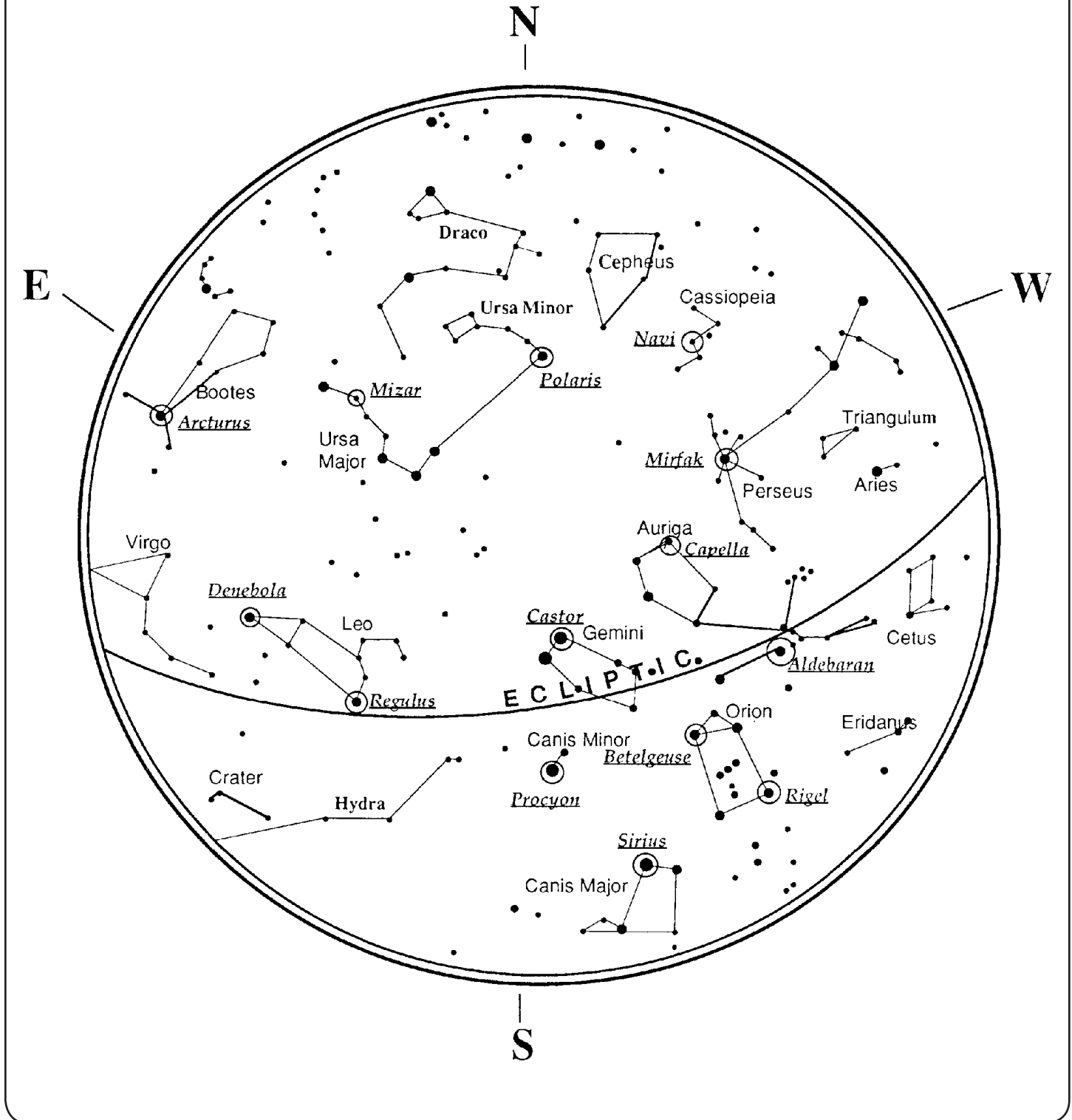

March - April Sky

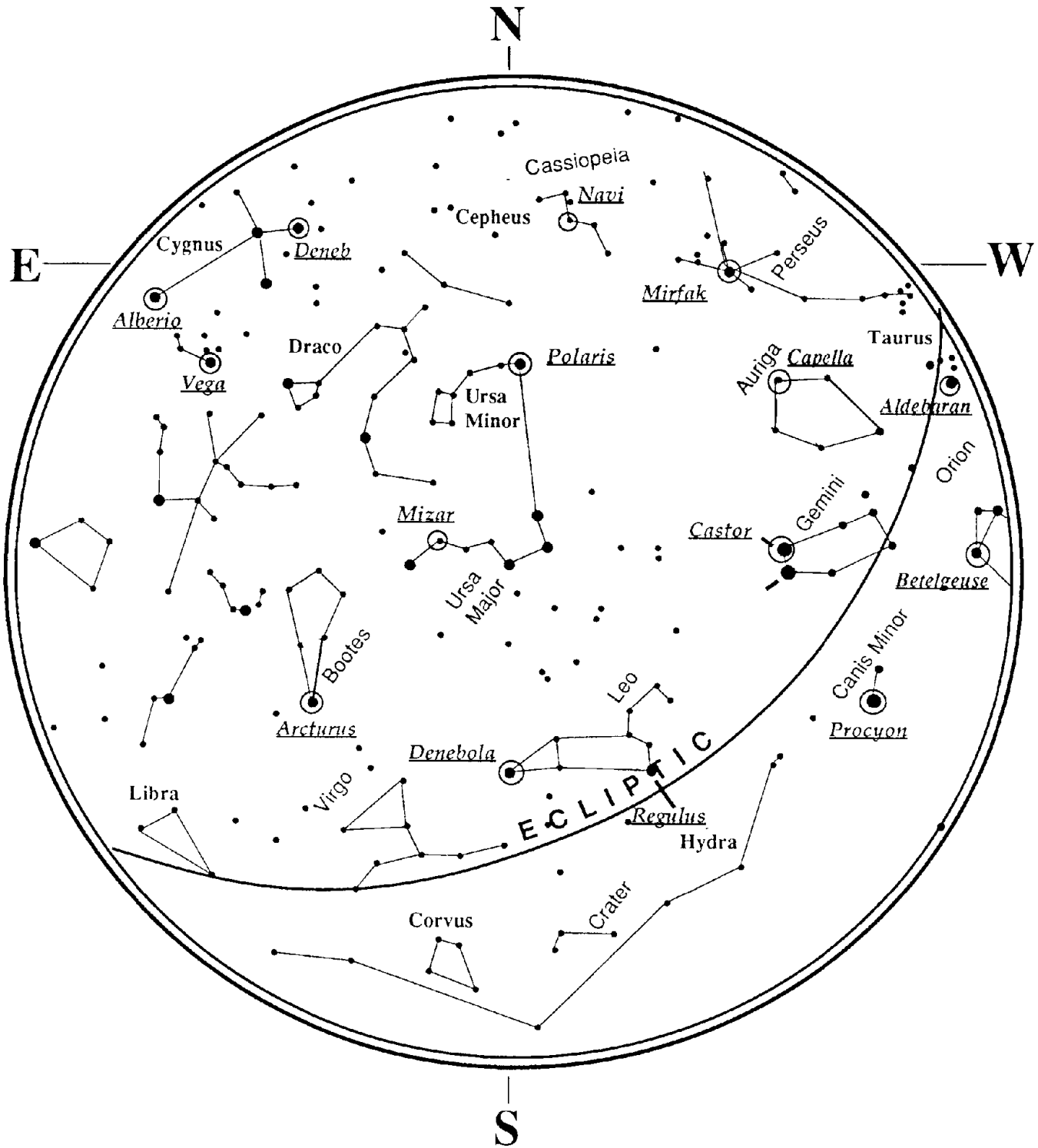

May - June Sky

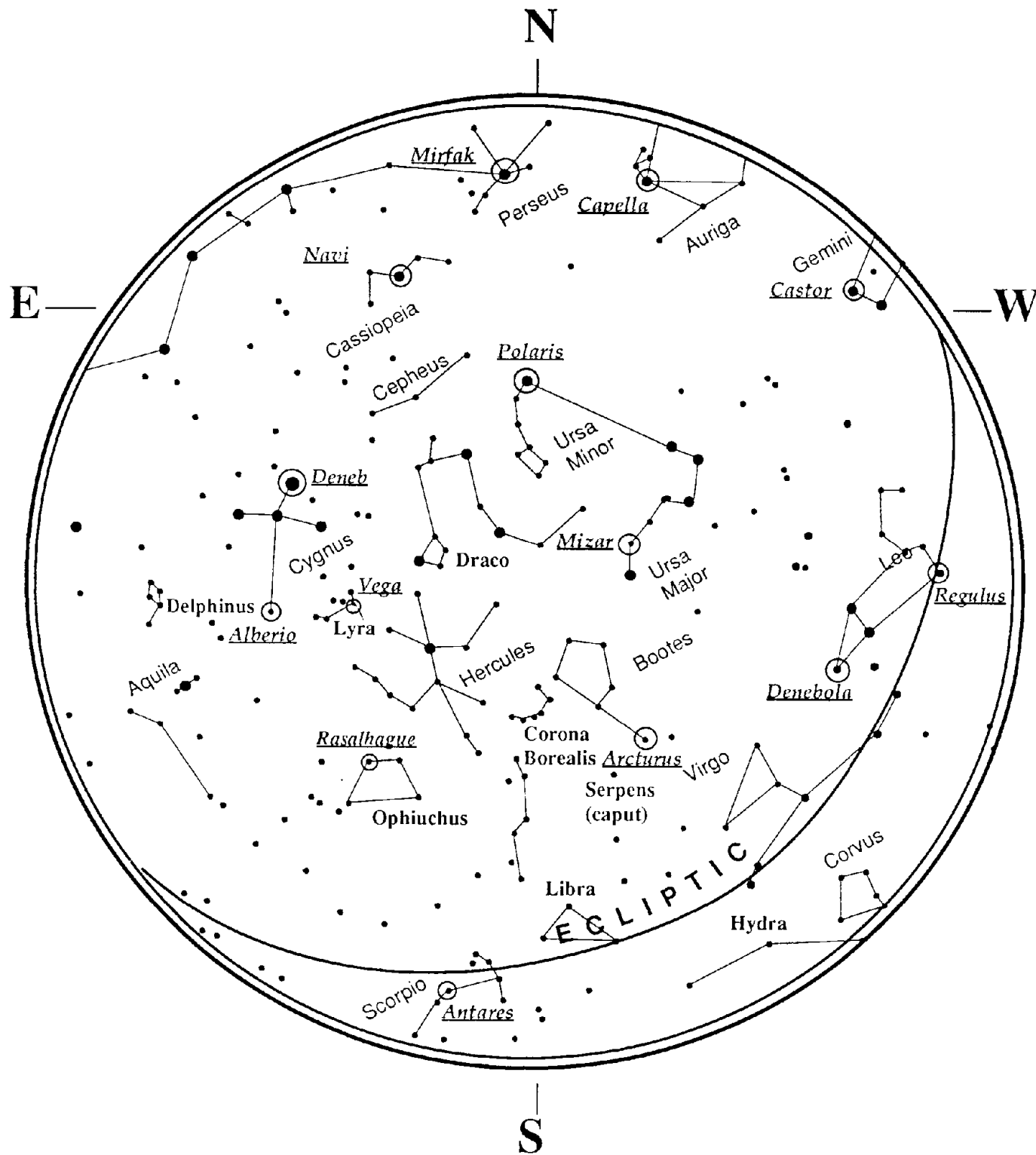

July - August Sky

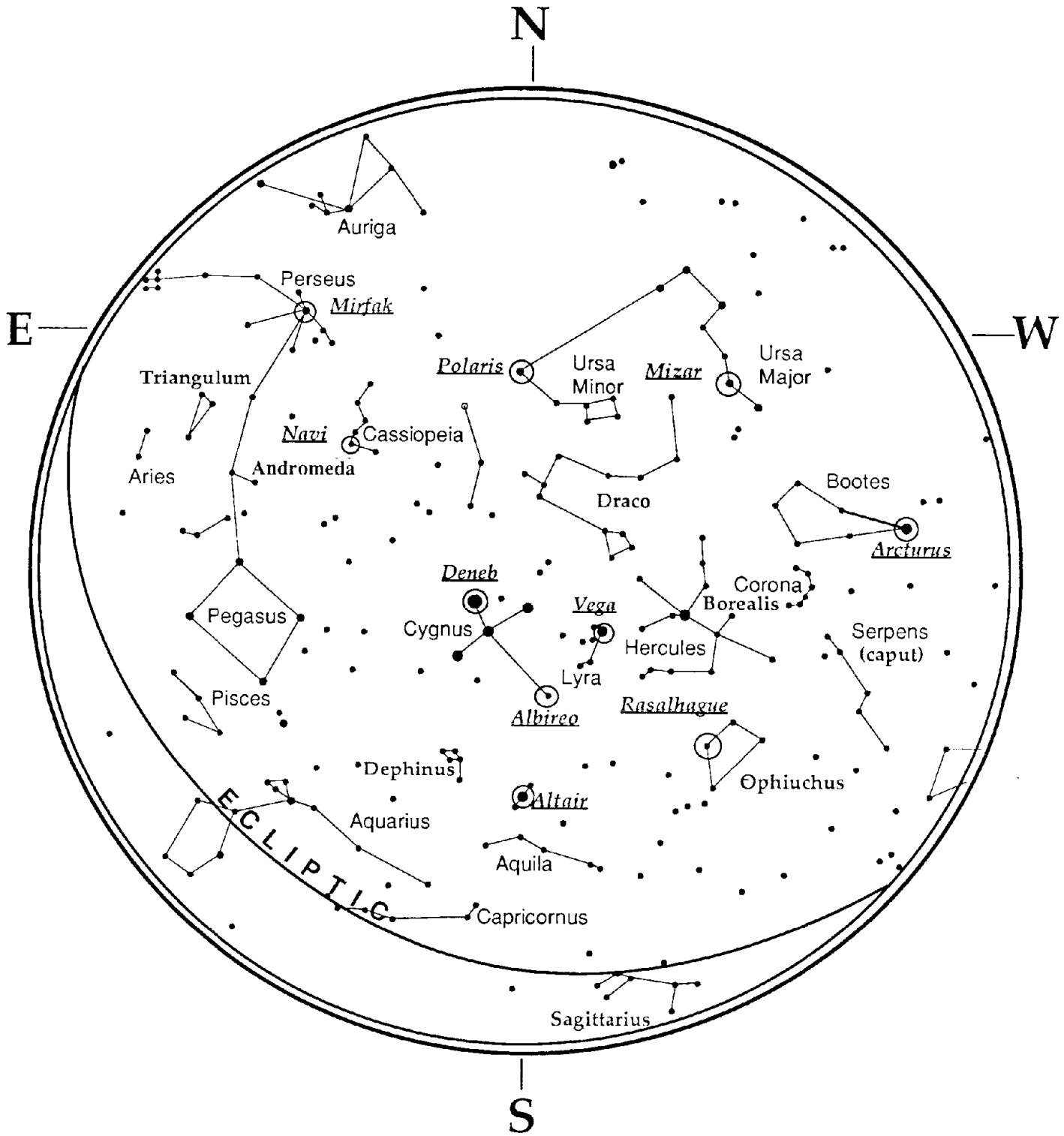

September - October Sky

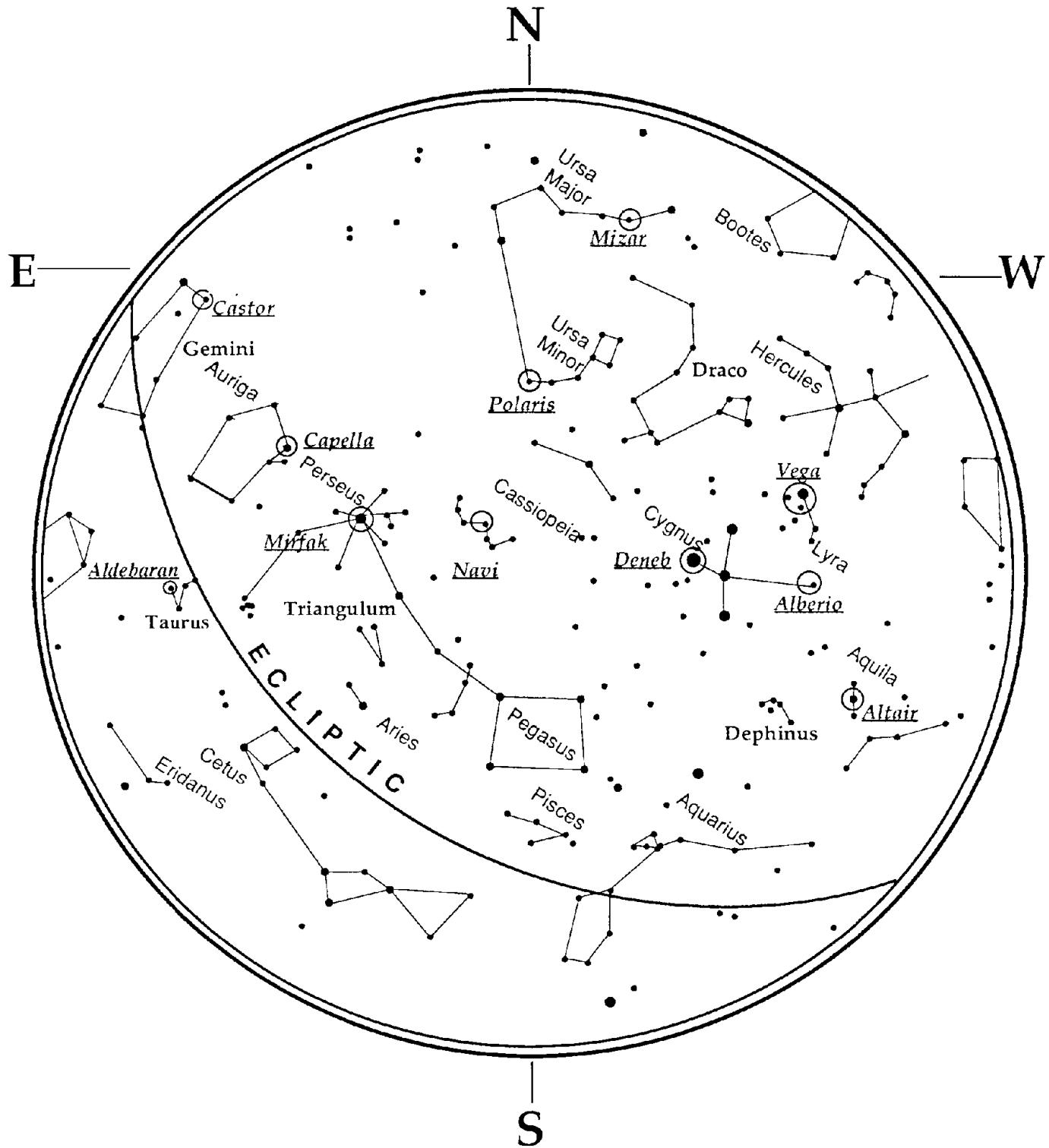

November - December Sky

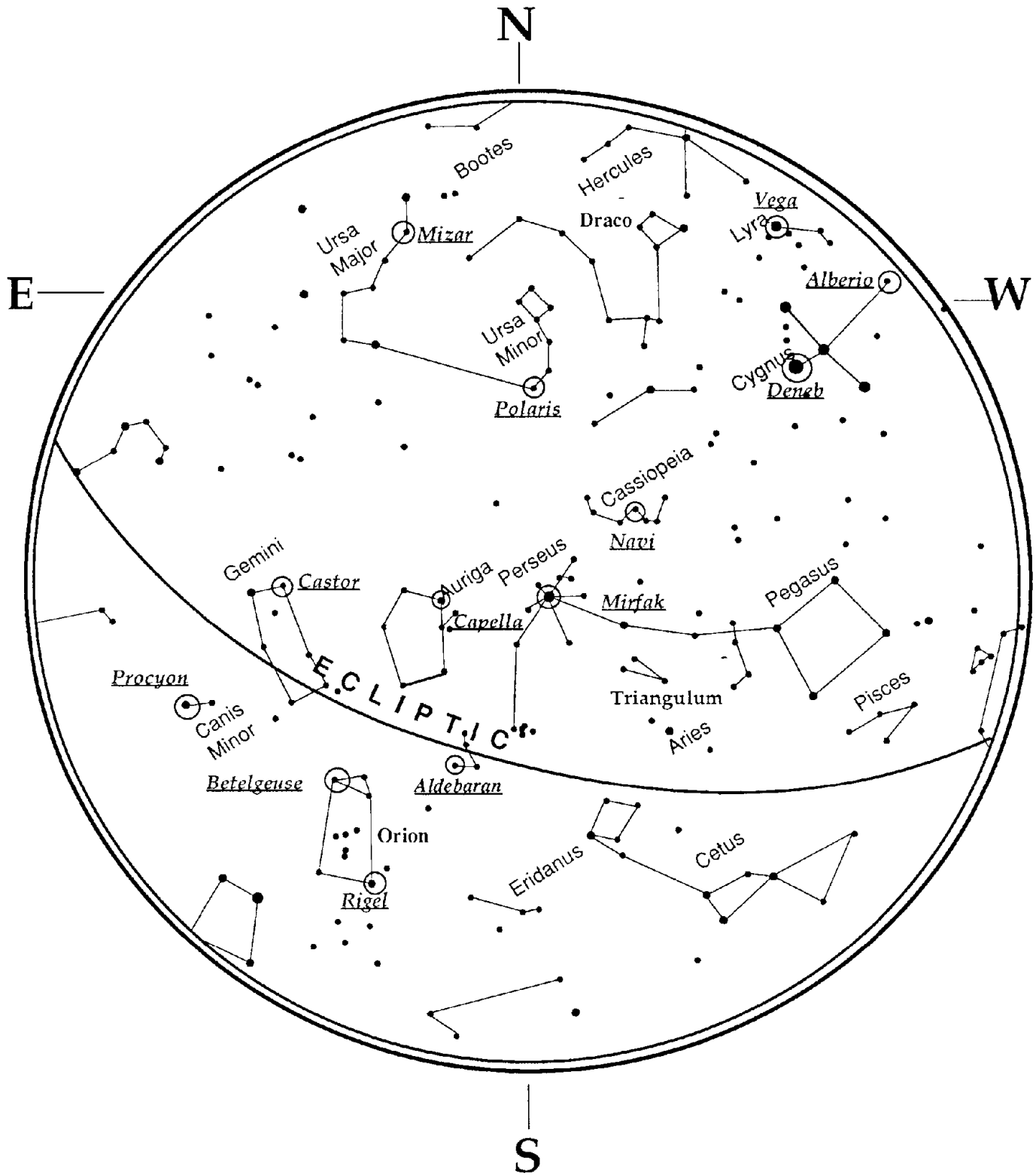

OBSERVATIONAL DATA SHEET

>> YEARLY METEOR SHOWERS

SHOWER	DATE	PEAK	HOURLY RATE
Quadrantids	Jan 01-Jan 05	4-Jan	60-200
Lyrids	Apr 16-Apr 25	21-Apr	15
pi-Puppids	Apr 15-Apr 28	23-Apr	Var.
eta-Aquarids	Apr 19-May 28	5-May	60
June Bootids	Jun 26-Jul 02	27-Jun	Var.
July Phoenicids	Jul 10-Jul 16	13-Jul	Var.
Southern delta-Aquarids	Jul 12-Aug 19	27-Jul	20
Perseids	Jul 17-Aug 24	12-Aug	120-160
Alpha-Aurigids	Aug 25-Sep 05	31-Aug	10
Draconids	Oct 06-Oct 10	8-Oct	Var*.
Orionids	Oct 02-Nov 07	21-Oct	20
Leonids	Nov 14-Nov 21	17-Nov	100*
alpha-Monocerotids	Nov 15-Nov 25	21-Nov	Var.
Phoenicids	Nov 28-Dec 09	6-Dec	Var.
Puppид-Velids	Dec 01-Dec 15	7-Dec	10
Geminids	Dec 07-Dec 17	13-Dec	120
Ursids	Dec 17-Dec 26	22-Dec	10

* These meteor showers have the potential of becoming meteor storms with displays of thousands of meteors per hour.

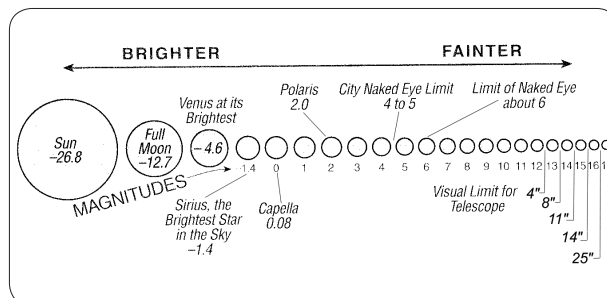

EACH MAGNITUDE IS ABOUT 2.5 TIMES BRIGHTER OR FAINTER THAN THE NEXT MAGNITUDE.

>> SOLAR ECLIPSES IN NORTH AMERICA PLUS TOTAL ECLIPSES AROUND THE WORLD

DATE	ECLIPSE TYPE	DURATION	LOCATION
2001 Dec 14	Annular	03m53s	North America, Hawaii
2001 Jun 21	Total	04m57s	South Africa, Madagascar
2002 Dec 04	Total	02m04s	S. Africa, Indonesia, Australia
2002 Jun 10	Annular	00m23s	West, Midwest, Hawaii, Alaska
2003 May 31	Annular	03m37s	Alaska
2003 Nov 23	Total	01m57s	Australia, New Zealand, S. America
2005 Apr 08	Partial	00m42s	Florida, Southwest
2006 Mar 29	Total	04m07s	Africa, Europe, Asia
2008 Aug 01	Total	02m27s	Europe, Asia
2009 Jul 22	Total	06m39s	Asia, Hawaii
2010 Jul 11	Total	05m20s	South America
2012 May 20	Annular	05m46s	West, Hawaii, Alaska
2012 Nov 13	Total	04m02s	Australia, S. America
2013 May 10	Annular	06m03s	Australia, N.Z.
2014 Oct 23	Partial		West, Midwest, Alaska
2015 Mar 20	Total	02m47s	Europe, N. Africa, Asia
2016 Mar 09	Partial	04m09s	Hawaii, Alaska
2017 Aug 21	Total	02m40s	Across the U.S.!
2019 Jul 02	Total	04m33s	S. America
2020 Dec 14	Total	02m10s	S. America

CELESTRON TWO YEAR WARRANTY

A. Celestron warrants this telescope to be free from defects in materials and workmanship for two years. Celestron will repair or replace such product or part thereof which, upon inspection by Celestron, is found to be defective in materials or workmanship. As a condition to the obligation of Celestron to repair or replace such product, the product must be returned to Celestron together with proof-of-purchase satisfactory to Celestron.

B. The Proper Return Authorization Number must be obtained from Celestron in advance of return. Call Celestron at (310) 328-9560 to receive the number to be displayed on the outside of your shipping container.

All returns must be accompanied by a written statement setting forth the name, address and daytime telephone number of the owner, together with a brief description of any claimed defects. Parts or product for which replacement is made shall become the property of Celestron.

The customer shall be responsible for all costs of transportation and insurance, both to and from the factory of Celestron, and shall be required to prepay such costs.

Celestron shall use reasonable efforts to repair or replace any telescope covered by this warranty within thirty days of receipt. In the event repair or replacement shall require more than thirty days, Celestron shall notify the customer accordingly. Celestron reserves the right to replace any product which has been discontinued from its product line with a new product of comparable value and function.

This warranty shall be void and of no force of effect in the event a covered product has been modified in design or function, or subjected to abuse, misuse, mishandling or unauthorized repair. Further, product malfunction or deterioration due to normal wear is not covered by this warranty.

CELESTRON DISCLAIMS ANY WARRANTIES, EXPRESS OR IMPLIED, WHETHER OF MERCHANTABILITY OF FITNESS FOR A PARTICULAR USE, EXCEPT AS EXPRESSLY SET FORTH HEREIN.

THE SOLE OBLIGATION OF CELESTRON UNDER THIS LIMITED WARRANTY SHALL BE TO REPAIR OR REPLACE THE COVERED PRODUCT, IN ACCORDANCE WITH THE TERMS SET FORTH HEREIN. CELESTRON EXPRESSLY DISCLAIMS ANY LOST PROFITS, GENERAL, SPECIAL, INDIRECT OR CONSEQUENTIAL DAMAGES WHICH MAY RESULT FROM BREACH OF ANY WARRANTY, OR ARISING OUT OF THE USE OR INABILITY TO USE ANY CELESTRON PRODUCT. ANY WARRANTIES WHICH ARE IMPLIED AND WHICH CANNOT BE DISCLAIMED SHALL BE LIMITED IN DURATION TO A TERM OF TWO YEARS FROM THE DATE OF ORIGINAL RETAIL PURCHASE.

Some states do not allow the exclusion or limitation of incidental or consequential damages or limitation on how long an implied warranty lasts, so the above limitations and exclusions may not apply to you.

This warranty gives you specific legal rights, and you may also have other rights which vary from state to state.

Celestron reserves the right to modify or discontinue, without prior notice to you, any model or style telescope.

If warranty problems arise, or if you need assistance in using your telescope contact:

Celestron
Customer Service Department
2835 Columbia Street
Torrance, CA 90503
Tel. (310) 328-9560
Fax. (310) 212-5835
Monday-Friday 8AM-4PM PST

This warranty supersedes all other product warranties.

NOTE: This warranty is valid to U.S.A. and Canadian customers who have purchased this product from an Authorized Celestron Dealer in the U.S.A. or Canada. Warranty outside the U.S.A. and Canada is valid only to customers who purchased from a Celestron Distributor or Authorized Celestron Dealer in the specific country and please contact them for any warranty service.



2835 Columbia Street • Torrance, CA 90503 U.S.A.
Telephone: 310.328.9560 • Fax: 310.212.5835

FCC Statement

This device complies with Part 15 of FCC Rules.
Operation is subject to the following two conditions:

1. This device may not cause harmful interference, and
2. This device must accept any interference received, including interference that may cause undesired operation.

©2011 Celestron
All rights reserved. • Printed in China • 05-11
Item # 11007-INST • \$10.00

Product design and specifications are subject to change
without prior notification.

Designed and intended for those 13 years of age and older.